

Investigation of Free Volume in Polymers by Positron Annihilation Lifetime Spectroscopy (PALS)

Master Thesis

by M. Qasim Shaikh

Under supervision of

Prof. Reinhard Krause-Rehberg



Martin-Luther-Universität

Halle-Wittenberg

Fachbereich Physik

Structure of the free volume

- free volume due to structural, static or dynamic, disorder
- important for several macroscopic properties of these materials,
- viscosity, molecular transport, structural relaxation, and physical aging

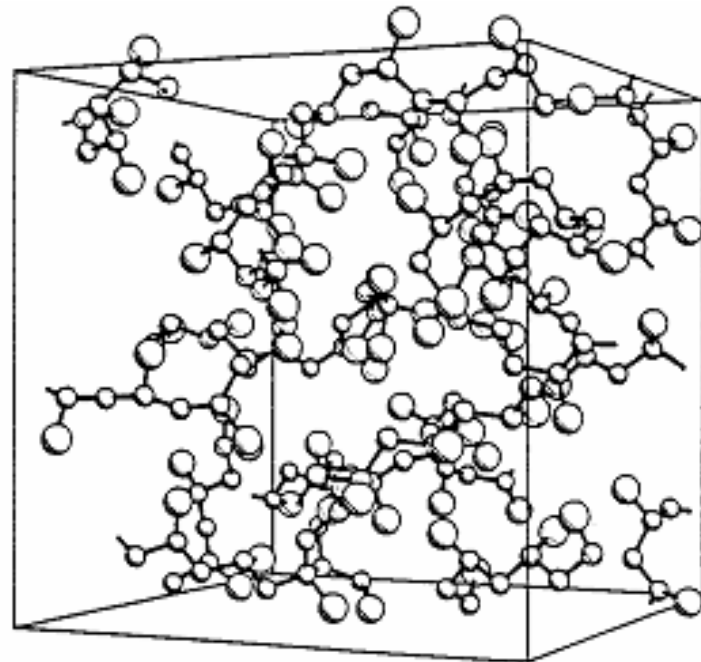

**Schematic representation of a
single Poly (Propylene)
microstructure (X=76)**

(Simulation, Theodoru et al. 1985)

Experimental Ways to determine Free Volume in Polymers

- **Positron Annihilation Lifetime Spectroscopy (PALS)**
 - Detection of subnanometric local free volumes (holes):
Size distribution (mean hole volume $\langle v_h \rangle$ and mean dispersion σ_h)
- **Pressure-Volume-Temperature-Experiments (PVT)**
Analysis by Simha-Somcynsky lattice-hole model EOS
 - Fraction of vacancies h , specific hole free. $V_f = hV$, and occupied volumes, $V_{occ} = (1-h)V$
- **Correlation of PALS and PVT**
 - allows estimation of PALS hole density $V_f = N_h \langle v_h \rangle$
 - All parameters of the structure of hole free volume can be obtained from PALS and PVT

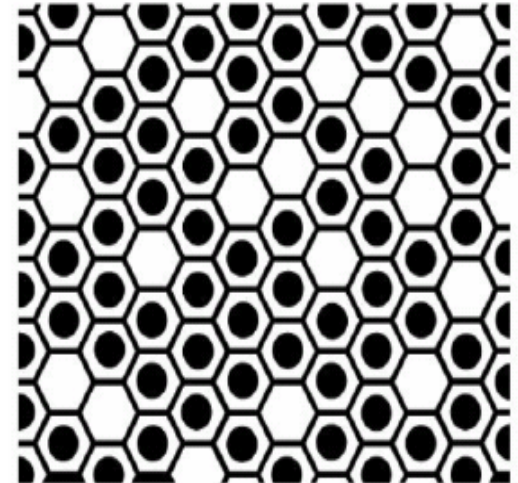

Basics of PALS

- β^+ decay: $^{22}\text{Na} \rightarrow ^{22}\text{Ne} + \beta^+ + \nu_e + \gamma_{(1.27\text{MeV})}$
(half life: 2.6 years, up to 10^6 e^+ /s)

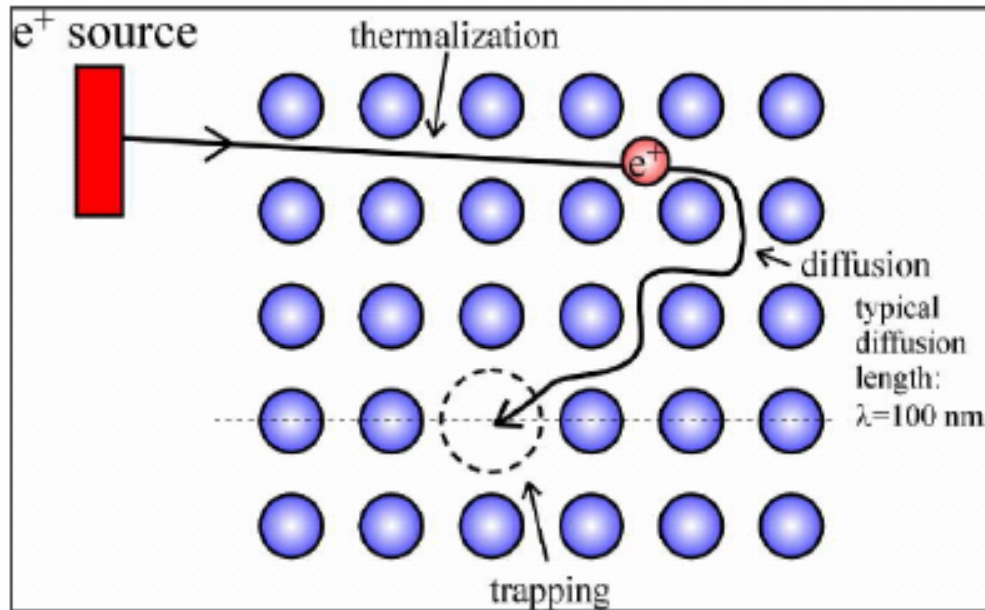
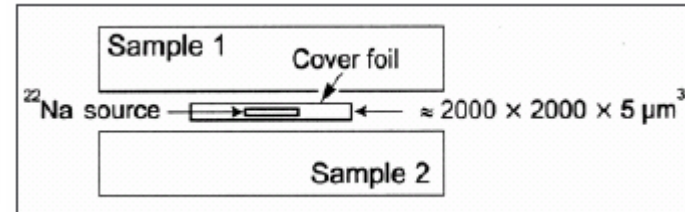

- Thermalization
- Diffusion
- Annihilation

Basic Principles and Theories of Positron Annihilation in Polymers

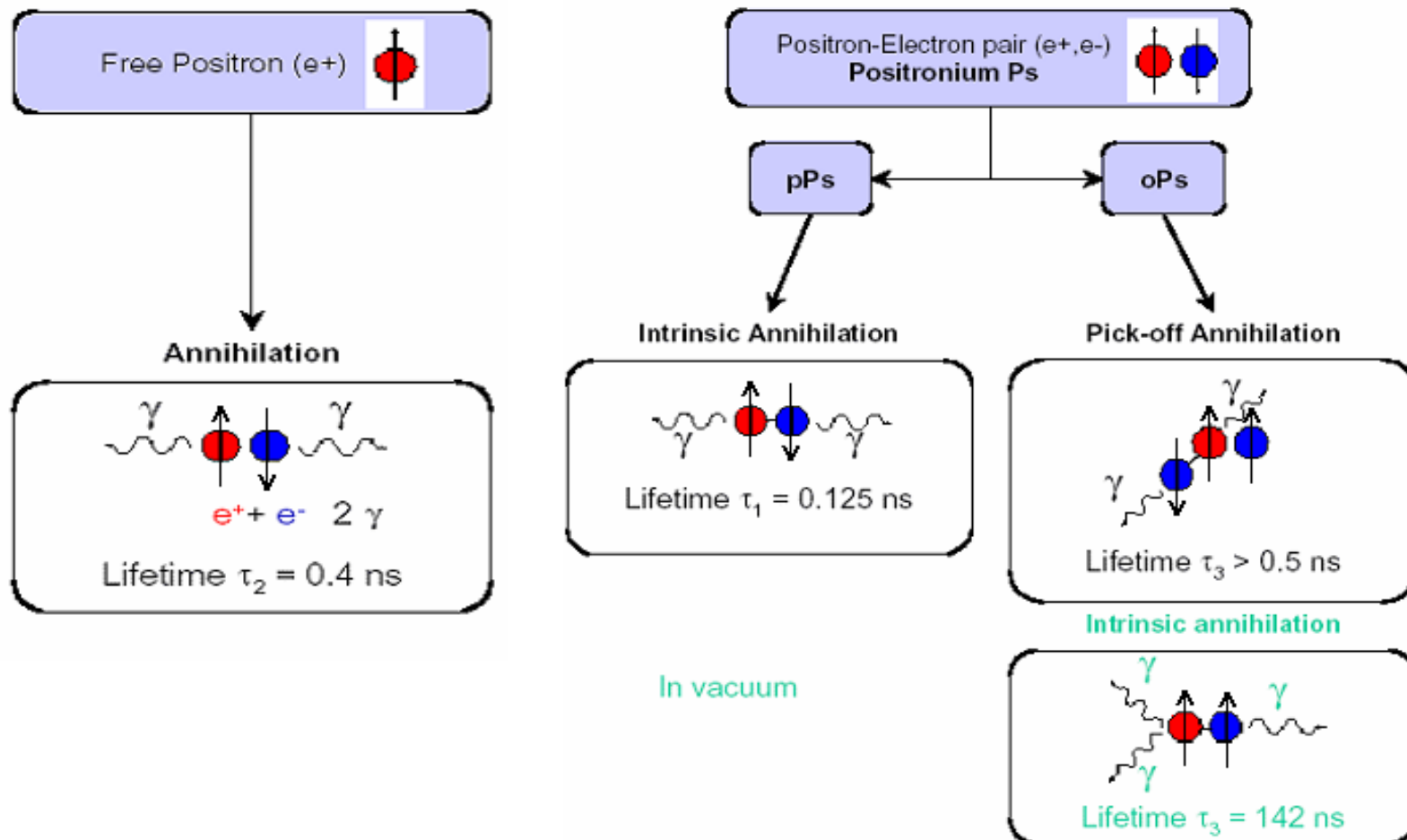

Ps Formation in Polymers

β^+ source

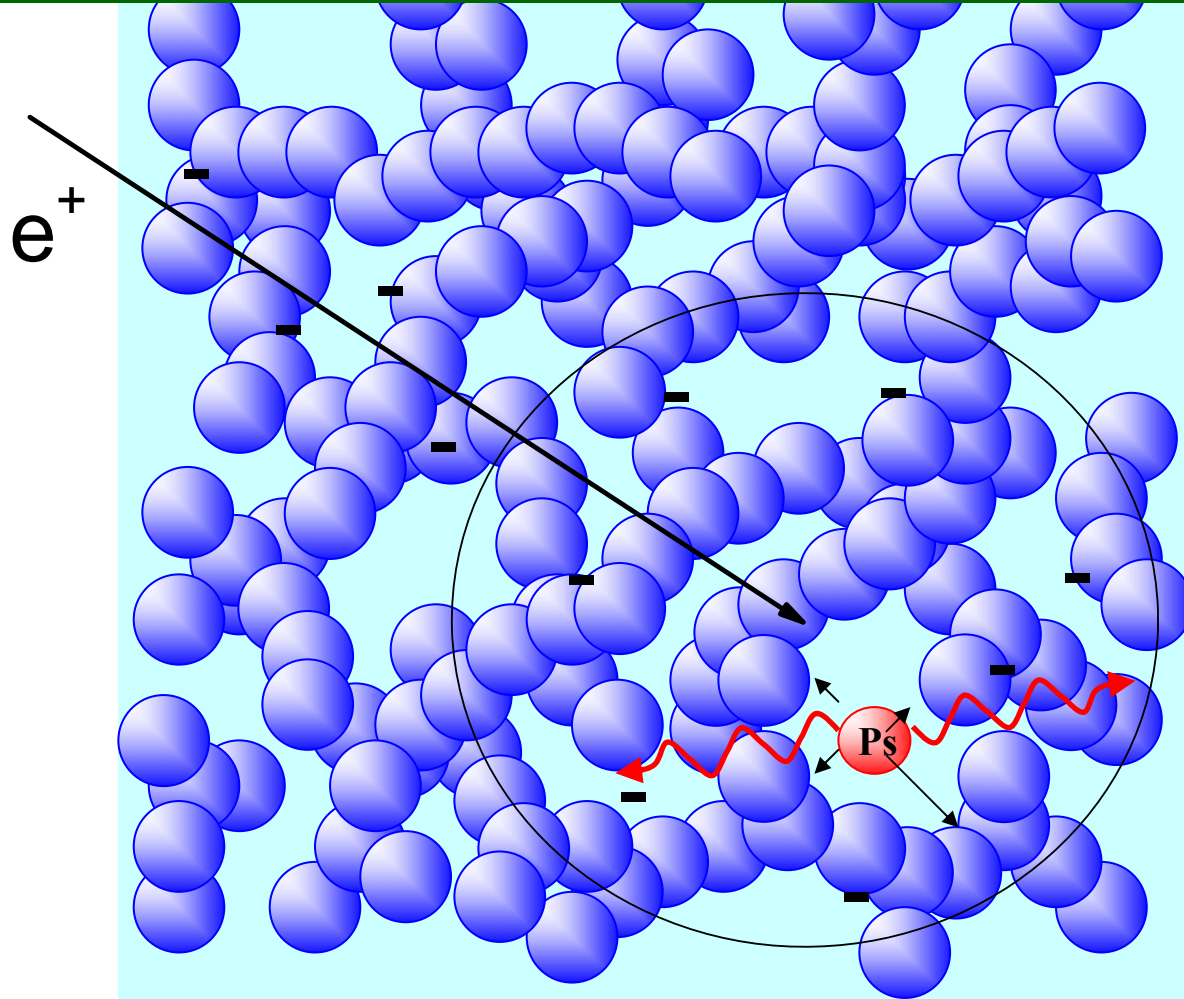

Pick-Off Annihilation

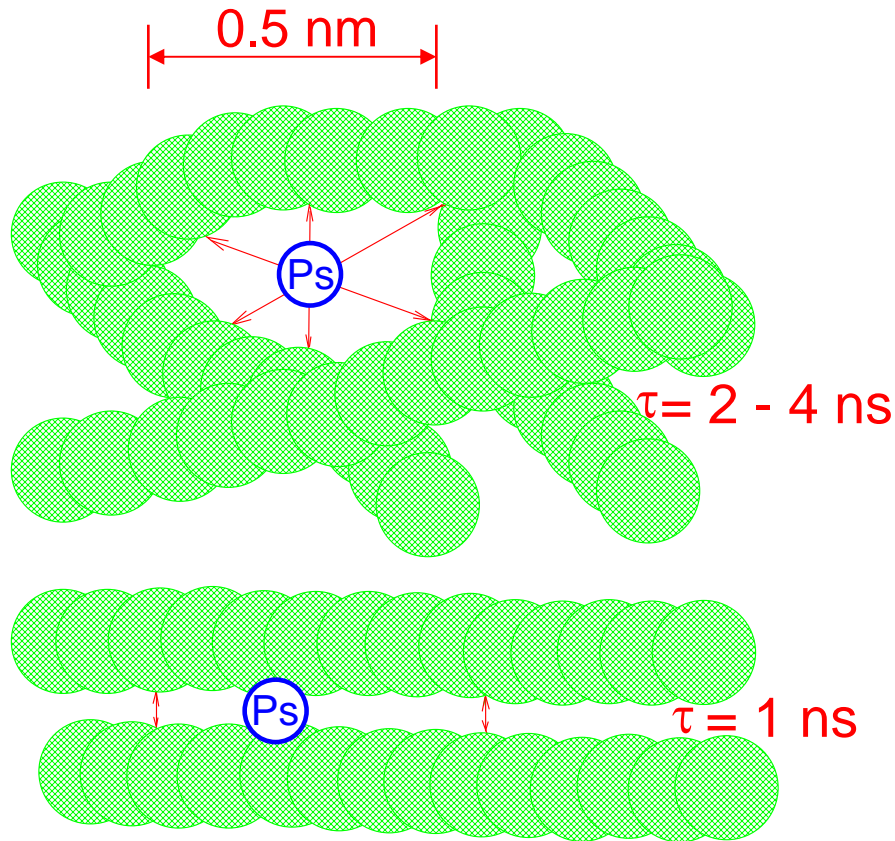

Ps localization in a hole of the (excess) free volume

Ps localization in interstitial free volume gives the packing coefficient 'C' of the crystals

Theory of Tau-Eldrup (TE) Model

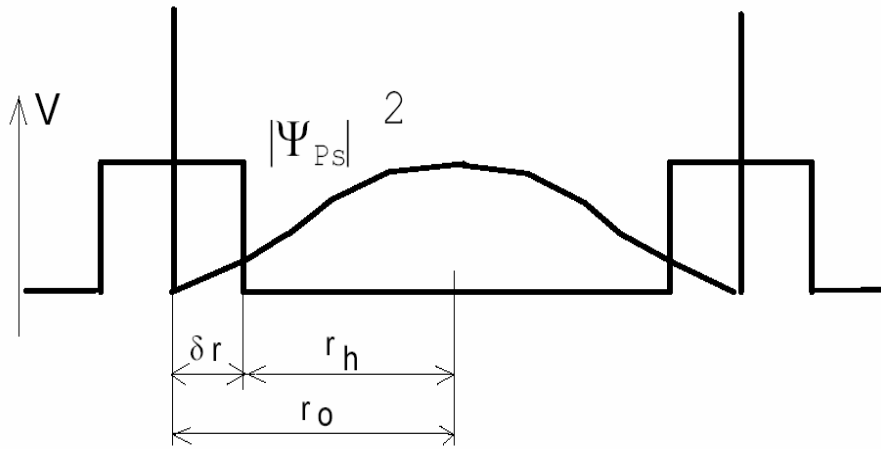

The height of the potential is infinity, and δr - empirical parameter $\delta r = 0.166 \text{ nm}$

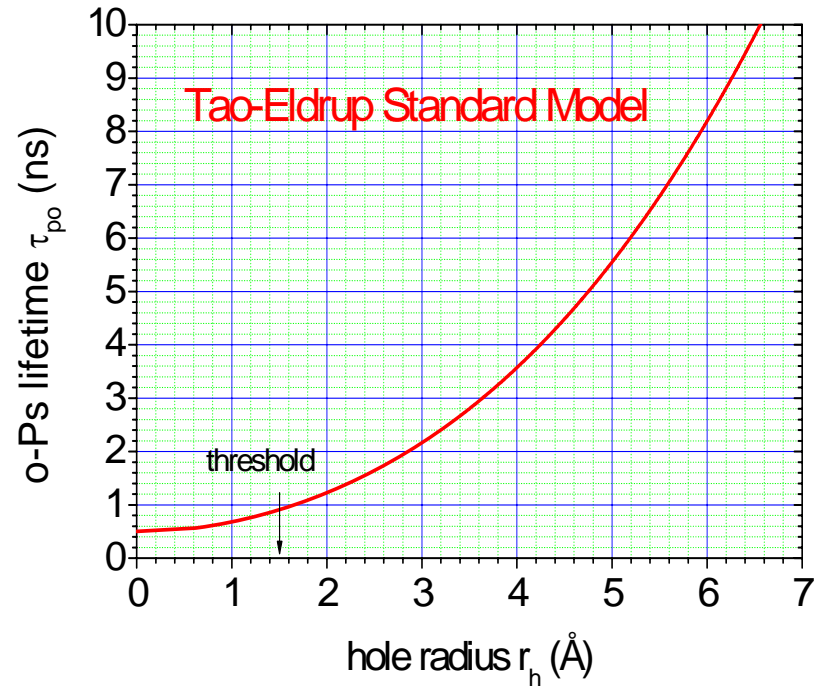

$$\tau_{o-Ps \text{ pickoff}} = \frac{0.5 \text{ ns}}{\left[1 - \frac{r_h}{r_h + \delta r} + \frac{1}{2\pi} \text{Sin} \left(\frac{2\pi r_h}{r_h + \delta r} \right) \right]}$$

mean hole volume

$$v_h(\tau_3) = (4/3)\pi r_h^3(\tau_3)$$

The Positron Lifetime Measurement

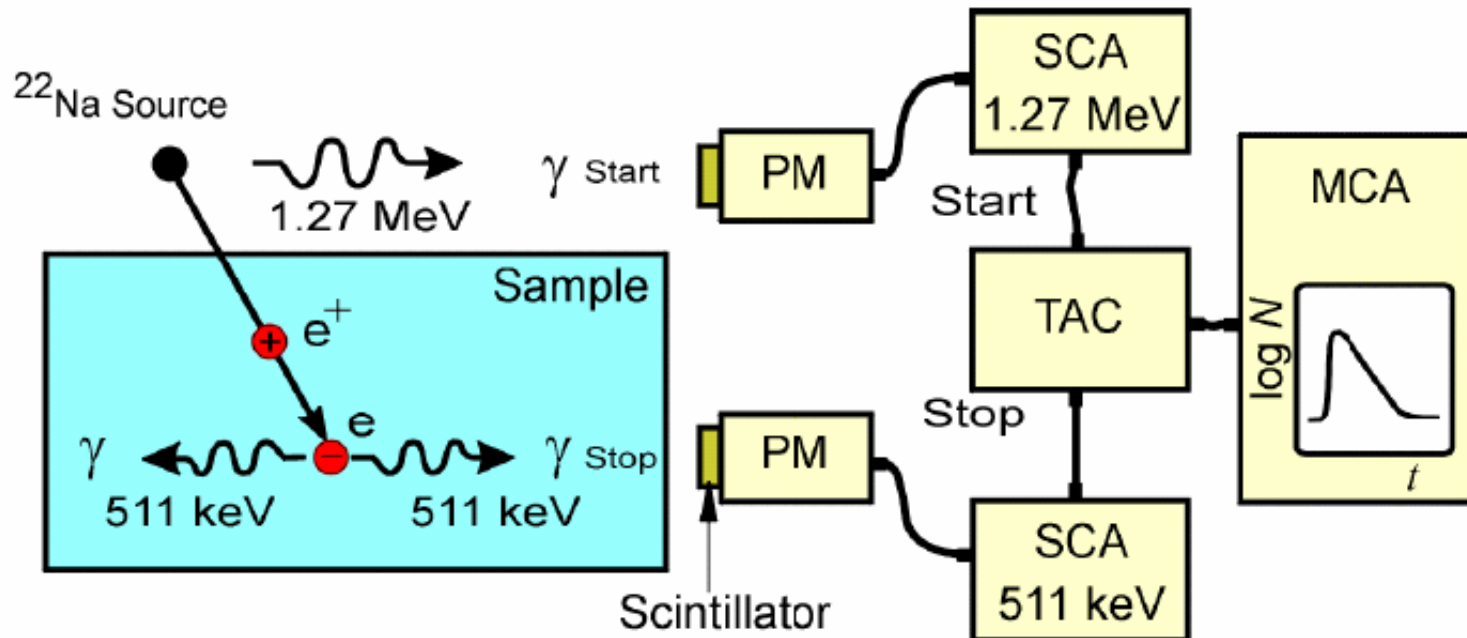

- Positron lifetime is measured as time difference between 1.27 MeV quantum (β^+ decay) and 0.511 MeV quanta (annihilation process)
- PM=photomultiplier; SCA=single channel analyzer (constant-fraction type); TAC=time to amplitude converter; MCA= multi channel analyzer

Positron Laboratory at MLU

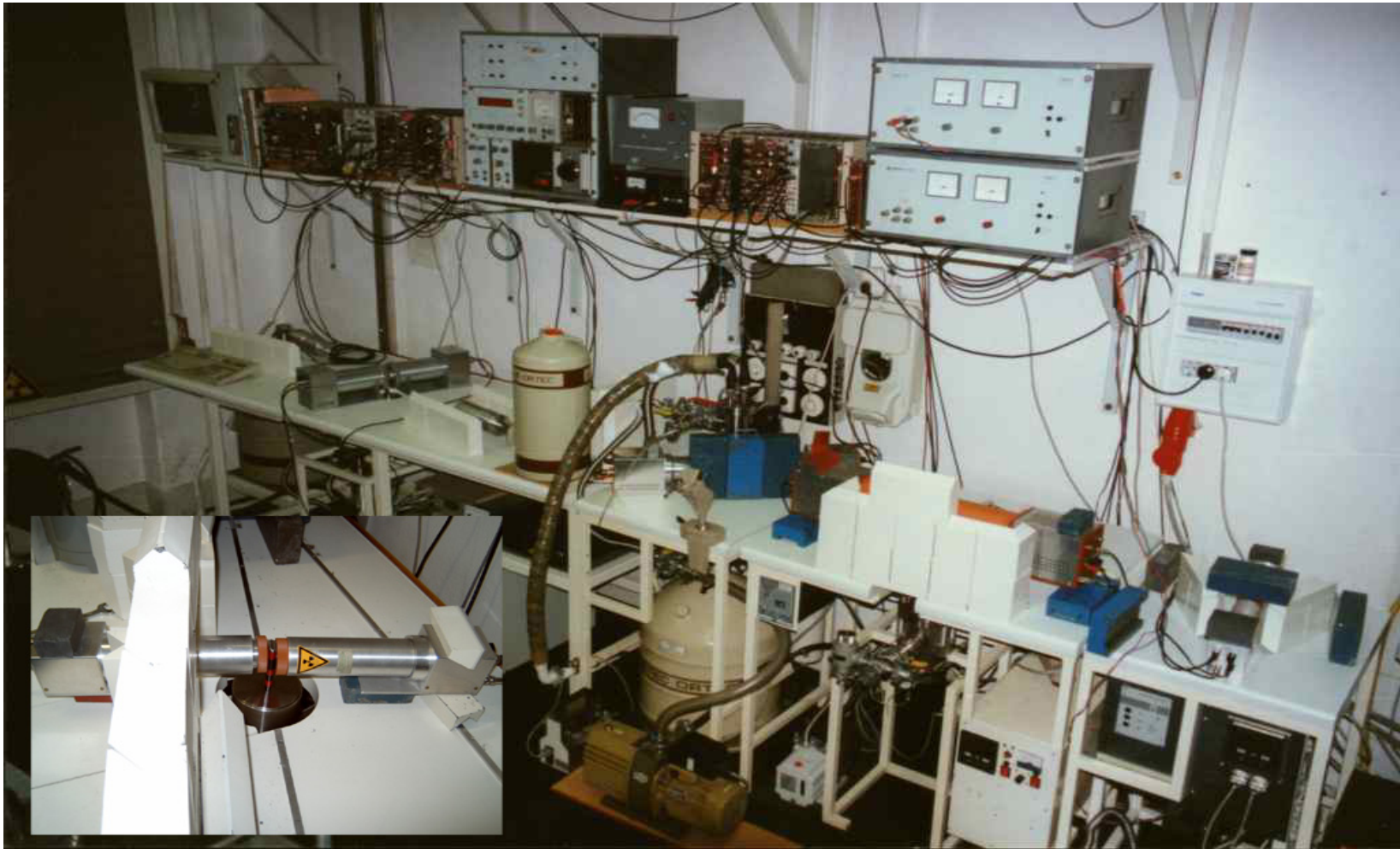

Typical PALS Spectrum

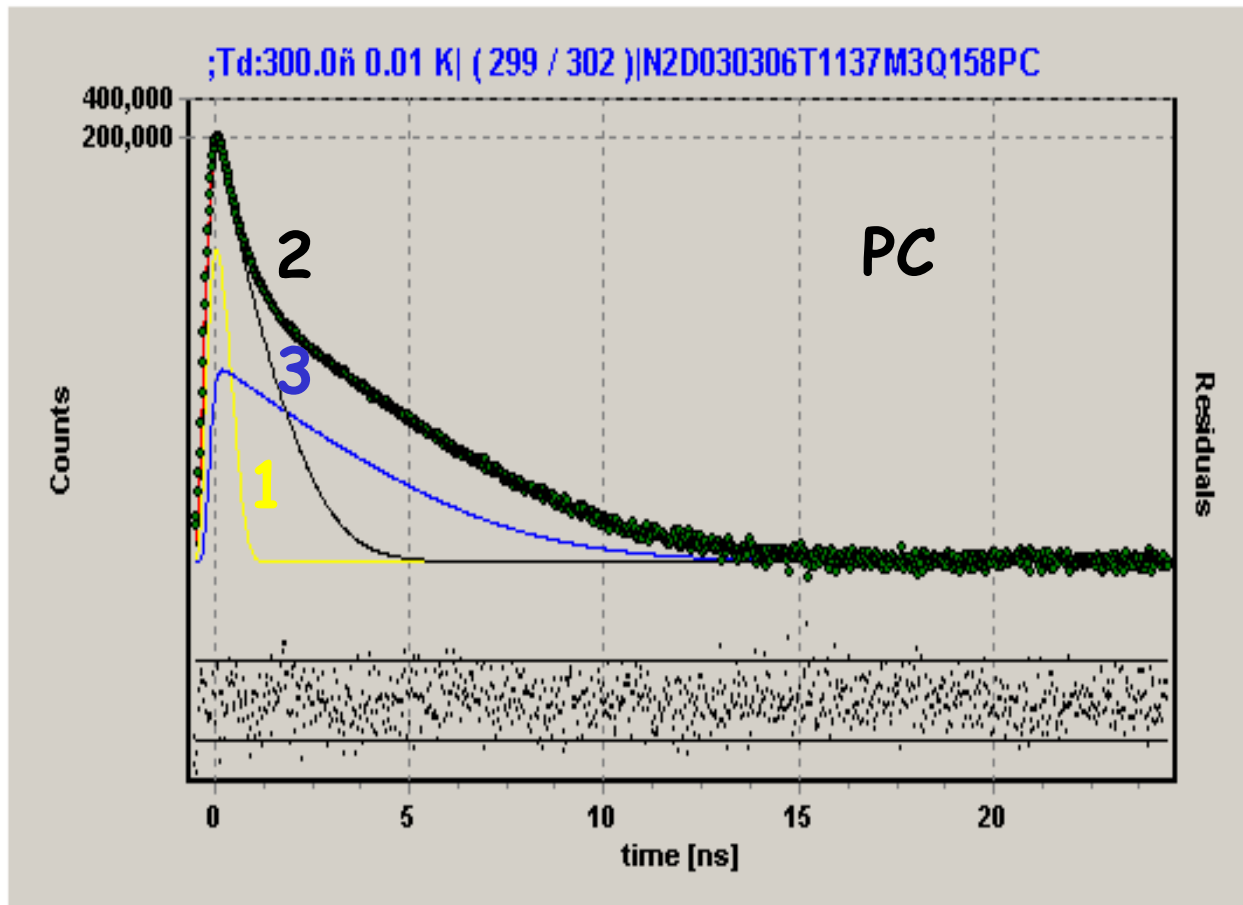

p-Ps

$$\tau_1 = 0,125 \text{ ns}$$

Free Annihilation

$$\tau_2 = 0,4 \text{ ns}$$

o-Ps (Pick-off
annihilation)

$$\tau_3 > 0,5 \text{ ns}$$

$$n(t) = I_1 \exp(-t/\tau_1) + I_2 \exp(-t/\tau_2) + I_3 \exp(-t/\tau_3)$$

Typical Lifetimes in Holes of:

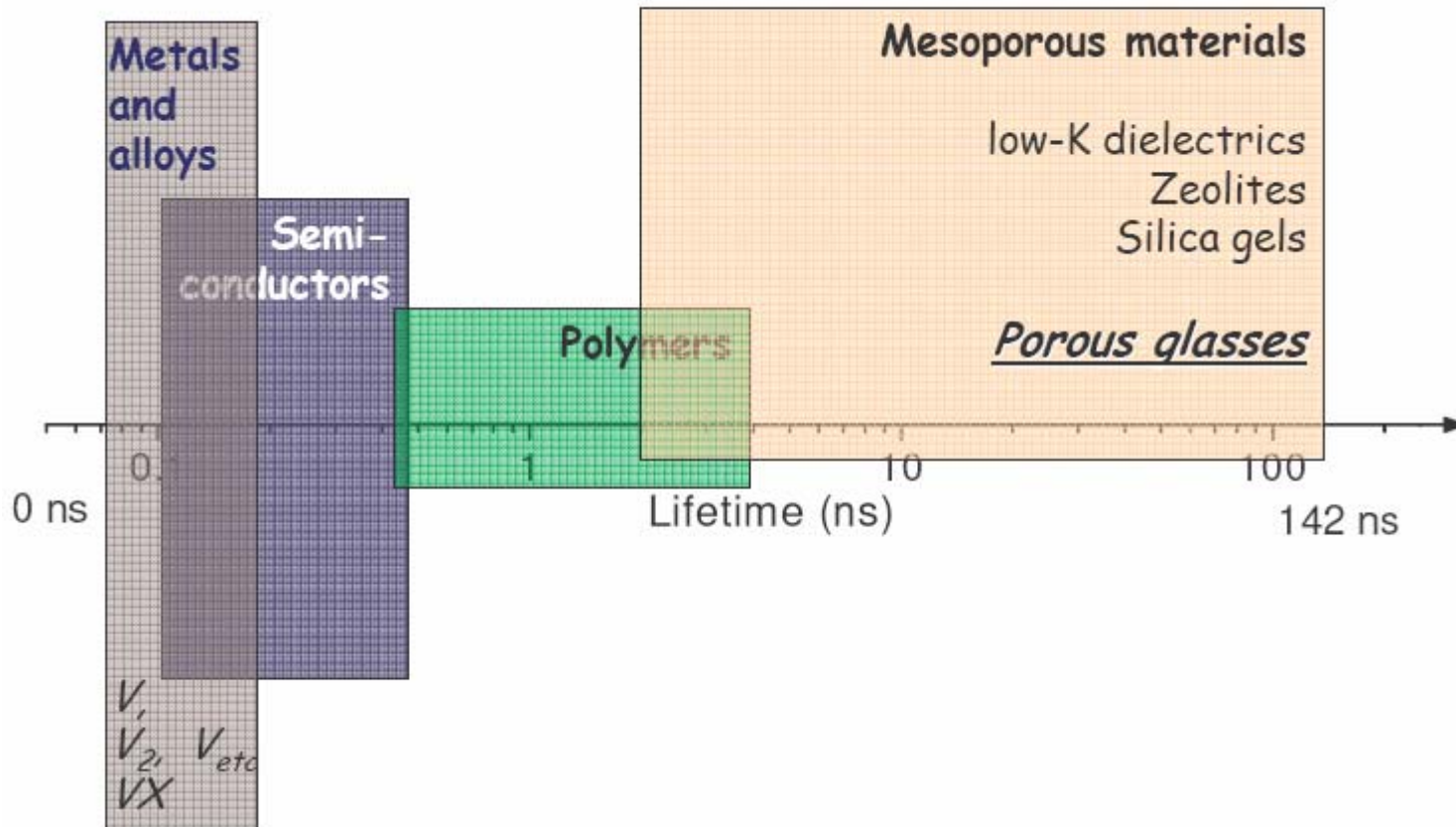

Analysis of COC and PC

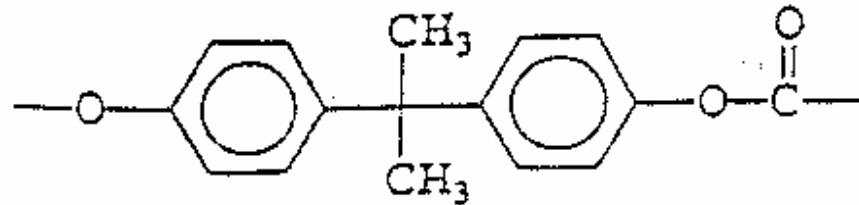
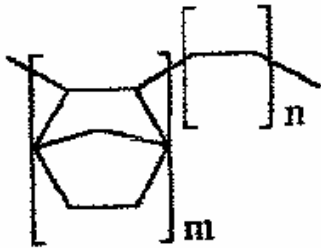

Cyclo Olefin Copolymer (COC)

Poly Carbonate (PC)



- Un-treated,
- Pressure Densified, and
- Gas Exposed.



V and V_{occ} vs T (K) [PVT]

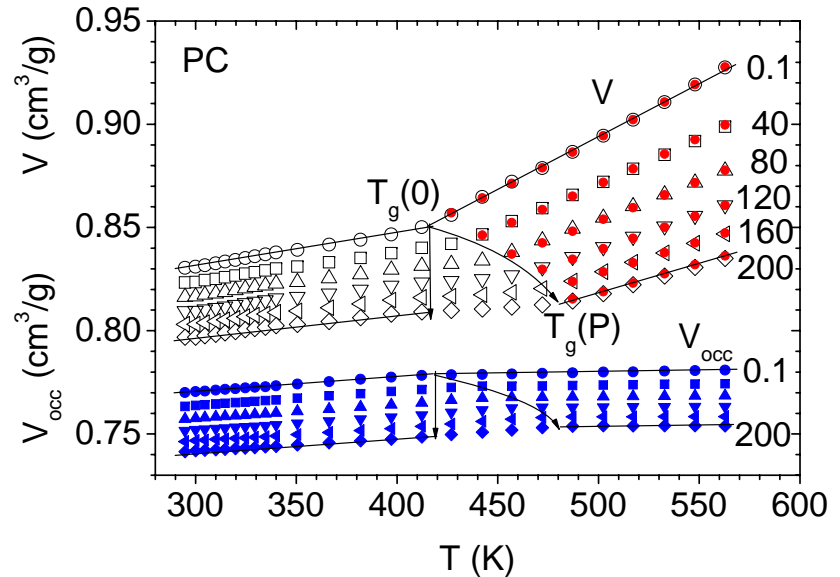
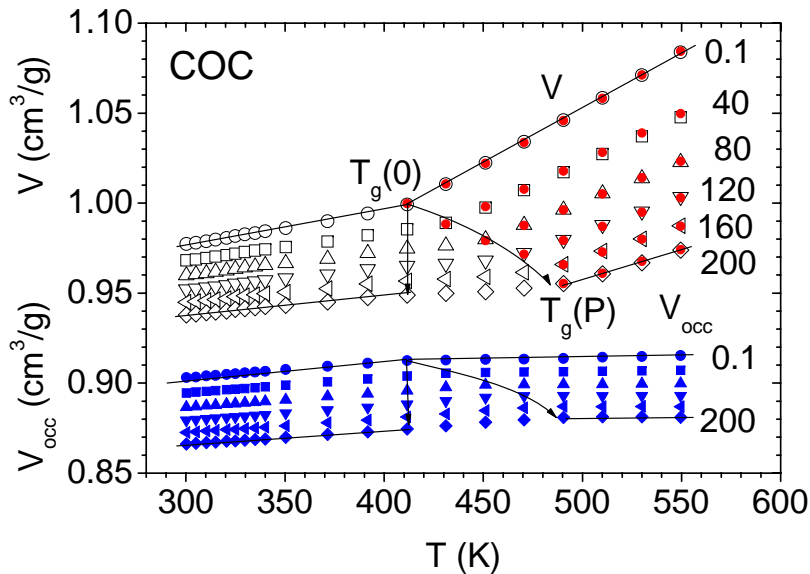

The specific total, V , (black open symbols), and occupied, $V_{occ} = (1 - h)V$ (blue symbols) volume as a function of temperature T and as selection of isobars (P in MPa) for COC and PC.

V_f vs $T(K)$

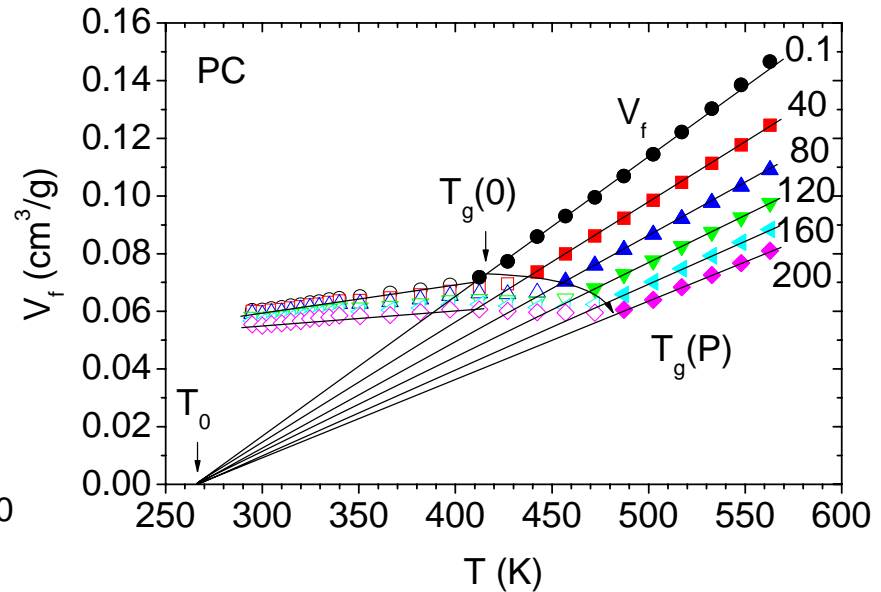
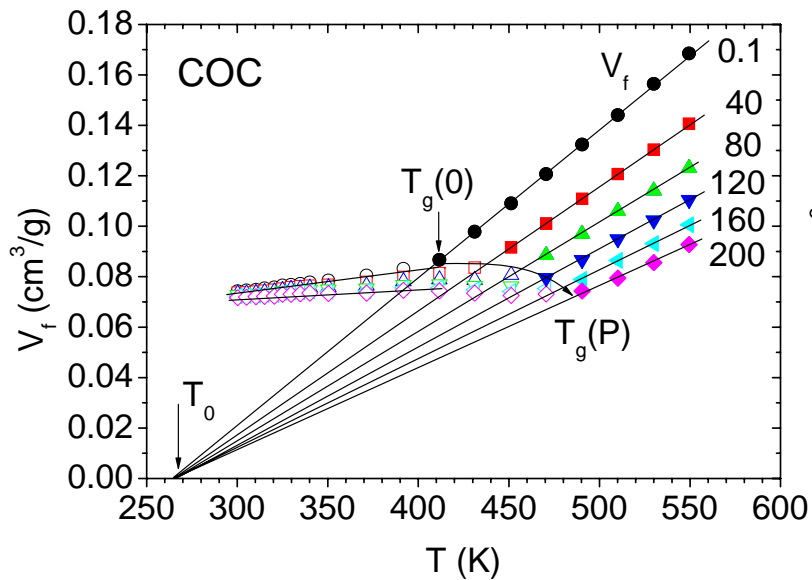

The specific hole free volume $V_f = hV$ as a function of temperature T and as selection of isobars (P in MPa) for COC and PC.

τ_3 and σ_3 vs T (K) [PALS]

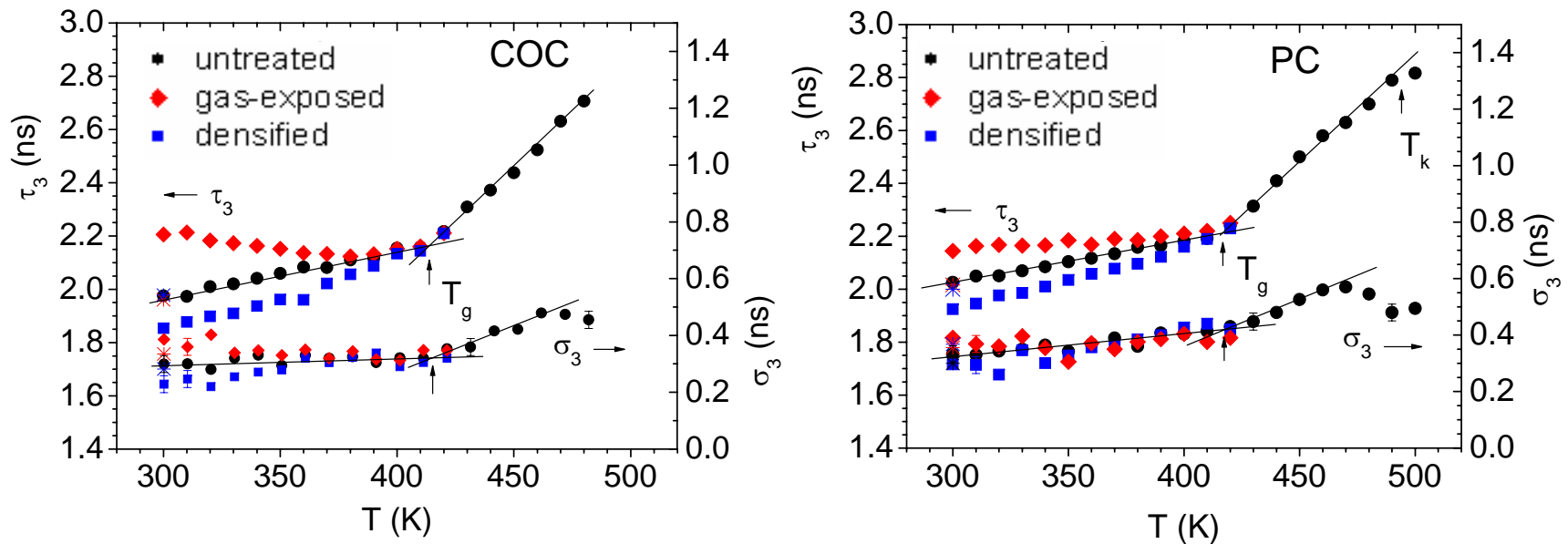

The mean, τ_3 , and the mean dispersion, σ_3 , of o-Ps lifetimes as a function of temperature T for densified at 200 MPa (blue), gas-exposed (red) and untreated (black) COC and PC.

Probability density function (pdf) [COC]

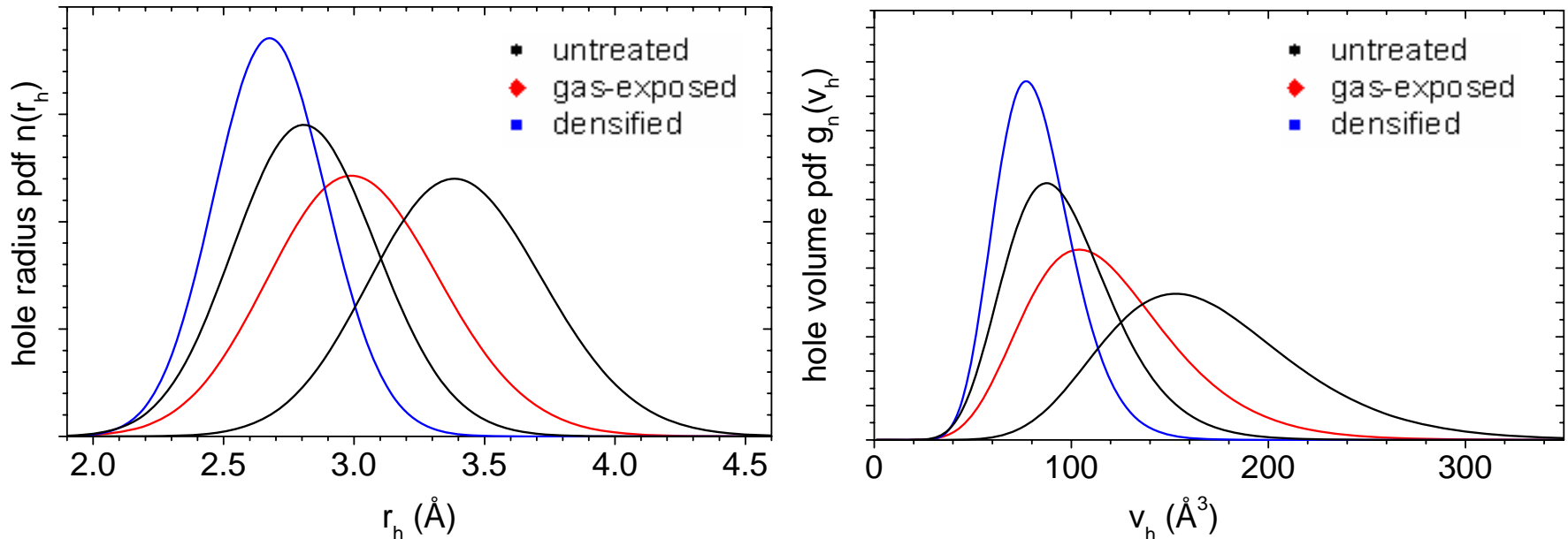

Probability density function (pdf) of the hole radius, $n(r_h)$, and hole volume, $g_n(v_h)$, for COC. Blue: densified, red: gas-exposed, black: untreated samples at 300 K (lower curve) and 480 K (upper curve).

V_h and σ_h vs $T(K)$

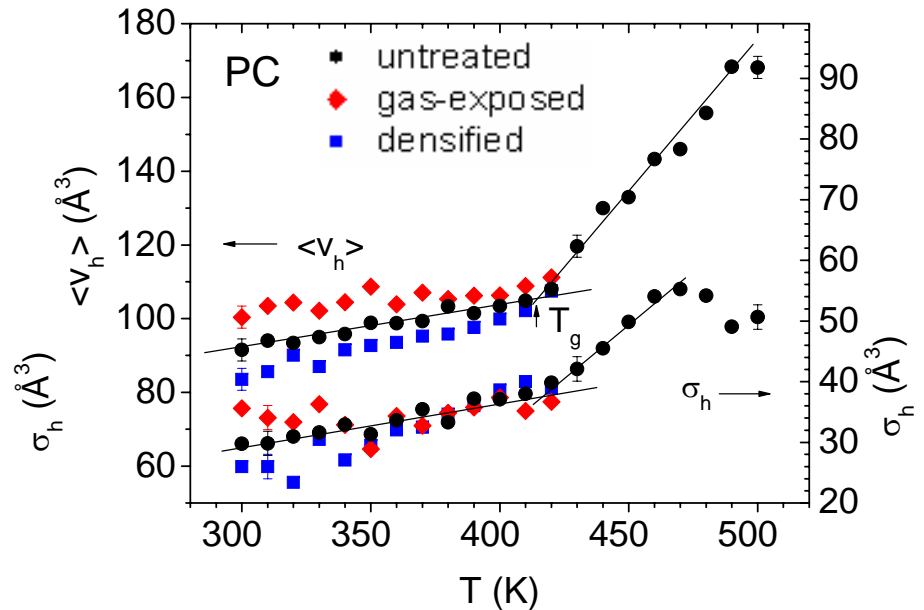
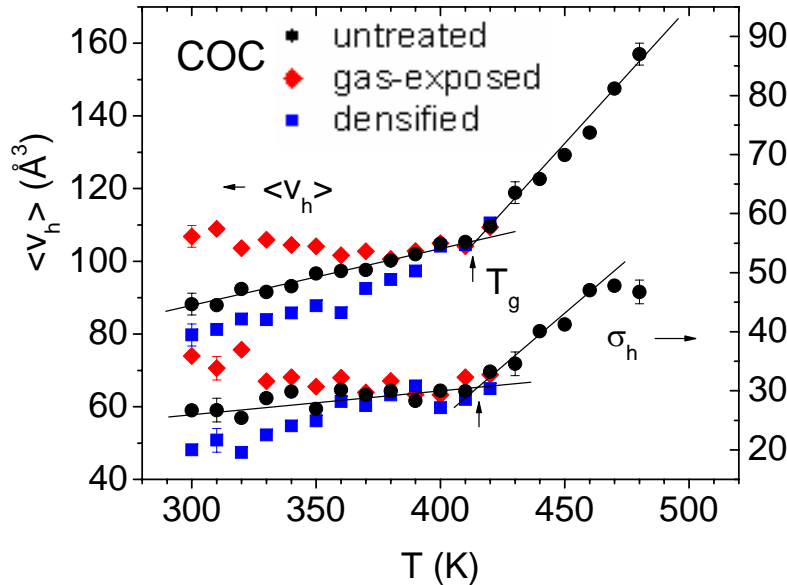

The mean, $\langle v_h \rangle$, and the mean dispersion, σ_h , of the hole volume as a function of temperature T for densified at 200 MPa (blue), gas-exposed (red) and untreated (black) COC and PC.

Hole density N_h'

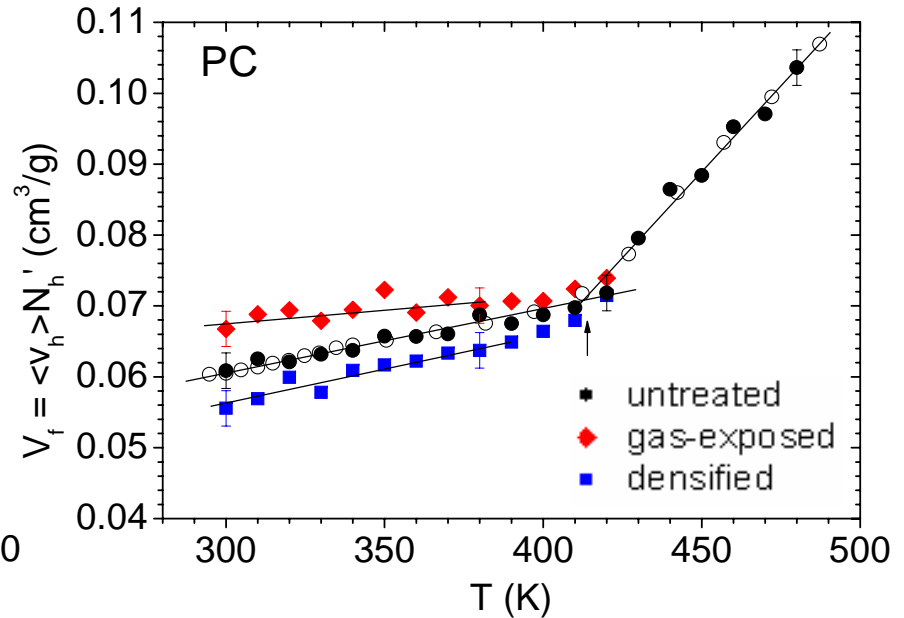
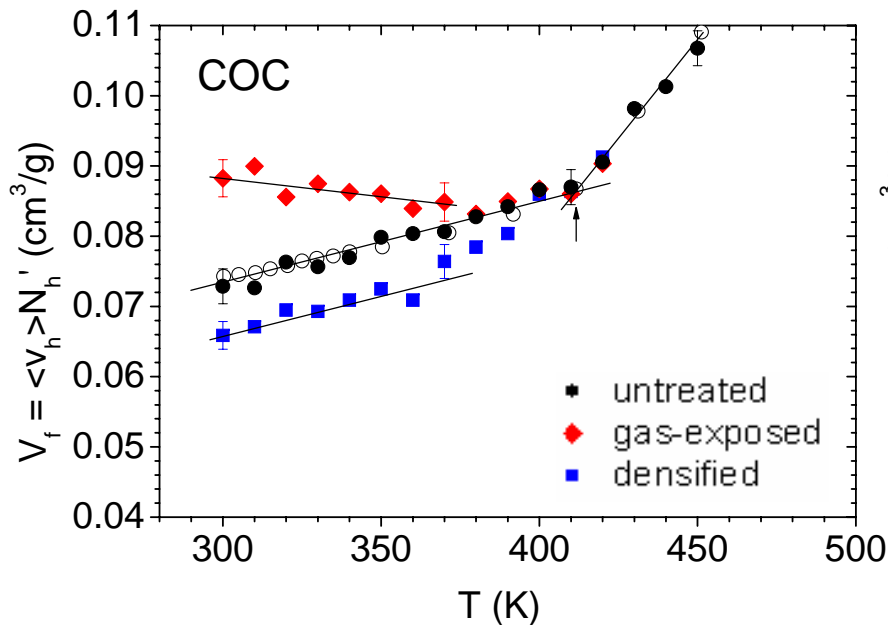

The specific free volume $V_f = \langle v_h \rangle N_h'$ from PALS at 10^{-5} Pa as a function of temperature for untreated (black filled circles), densified at 200 MPa (blue squares), and gas-exposed (red diamonds) COC and PC. The black empty circles show 0.1 MPa isobars from PVT experiments for the untreated polymers, $V_f = hV$.

$(V_f \text{ and } V) \text{ vs } V_h$

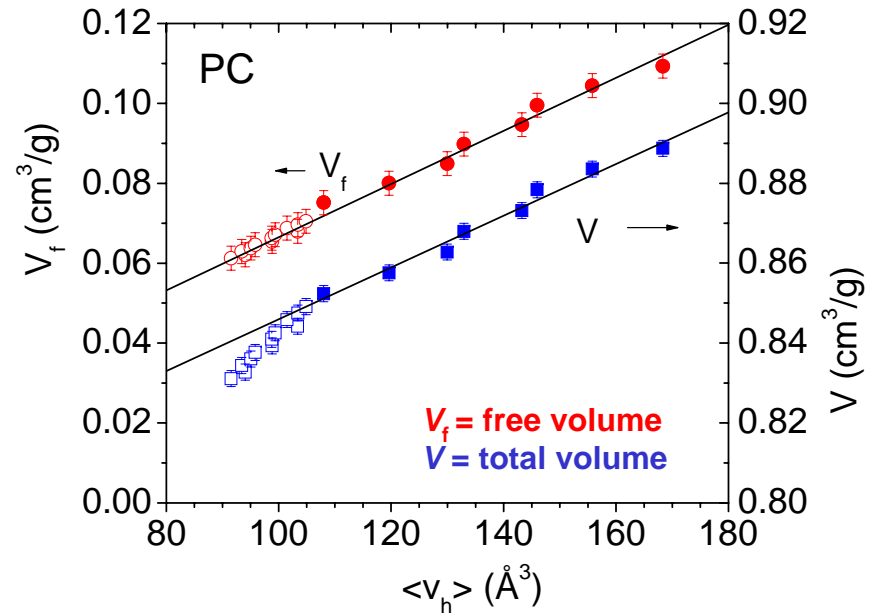
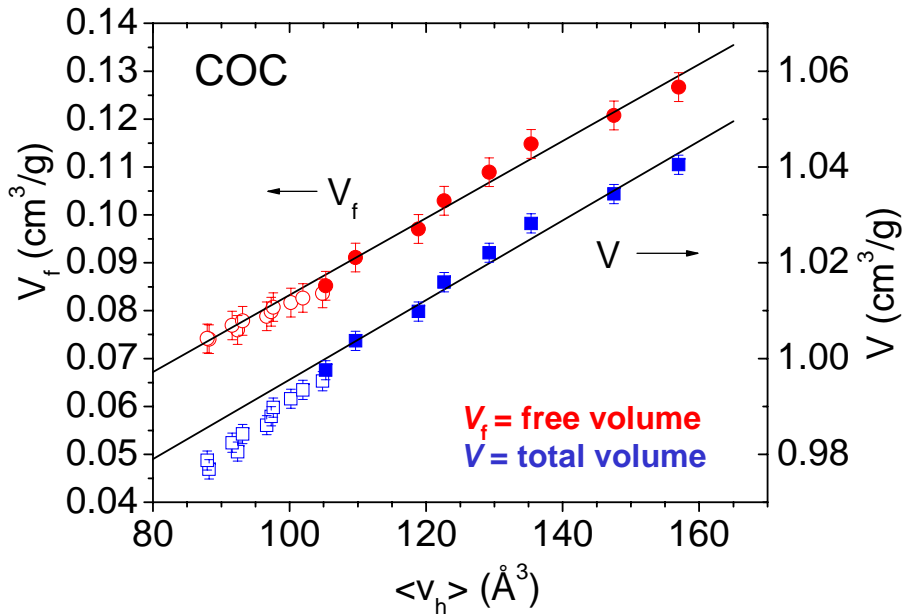

Plots of the **specific free, $V_f(T)$ (red)**, and **total, $V(T)$ (blue)** volume vs. the mean hole volume $\langle v_h(T) \rangle$ for COC and PC. Data from above T_g are shown by filled symbols, those from below by empty symbols.

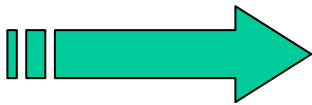

$$V_f = hV = N_h' \langle v_h \rangle$$

$$V = V_{\text{occ}} + N_h' \langle v_h \rangle$$

Epoxy Resin (DGEBA)

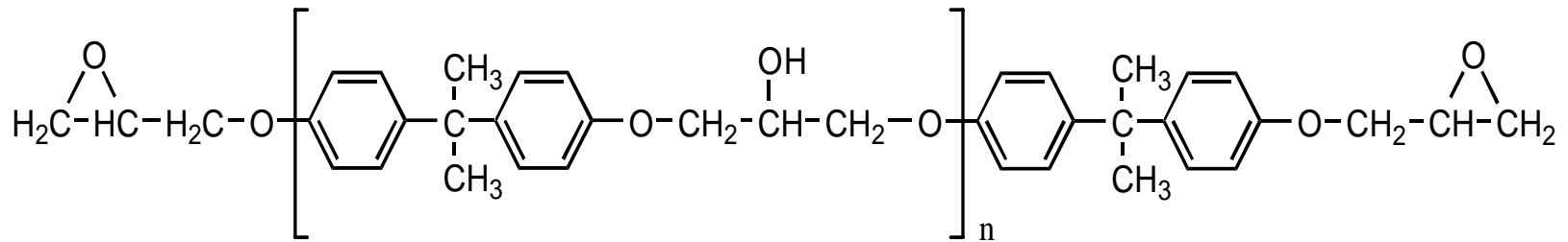

**Resin of diglycidyl ether of
bisphenol-A (DGEBA)**

V_f = free volume

V = total volume

Epoxy Resin (DGEBA)

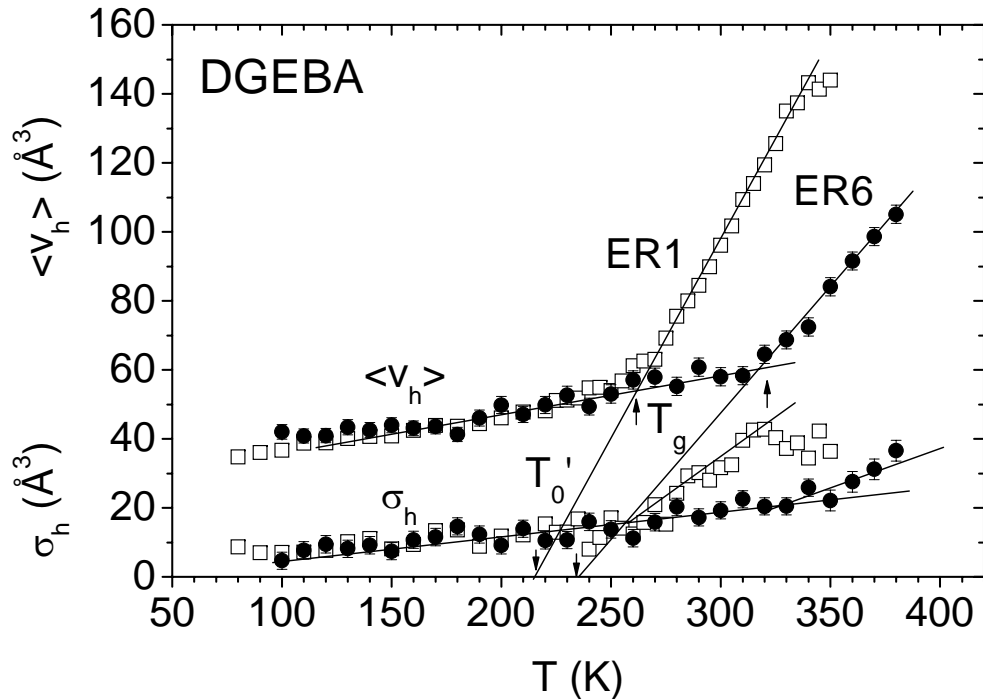

ER1 - monomer of
DGEBA ($n \approx 0.18 = 1$ unit)

ER6 - oligomer of
DGEBA ($n \approx 5 = 6$ units)

The mean hole volume, $\langle v_h \rangle$, and the mean hole volume dispersion, σ_h , as a function of the temperature T for ER6 (filled symbols) and ER1 (empty symbols).

Acknowledgement

- **Emeritus Prof. Günter Dlubek,**
ITA Institut für innovative Technologien GmbH, Halle, Germany.
- **Prof. Reinhard Krause-Rehberg,**
Fachbereich Physik, Martin-Luther University, Halle, Germany.
- **Dr. Jürgen Pionteck,**
Leibniz Institut für Polymerforschung, e.V., Dresden, Germany.
- **Dr. Doz. Dr. habil. Marian Paluch, Institute of Physics,**
Silesian University, Katowice, Poland,
- **Dr. Jerzy Kansy**
Institute of Physics and Chemistry of Metals,
Silesian University, Katowice, Poland.