"Characterization of nanoporous materials by positron annihilation spectroscopy"

R. Krause-Rehberg
S. Thraenert, E.M. Hassan, D. Enke



Martin-Luther-Universität
Halle-Wittenberg

Characterization of nanoporous materials by positron annihilation spectroscopy

- Positron annihilation lifetime spectroscopy (PALS)
 - Application in crystalline materials
 - Positronium as bound state of Positron and Electron
 - Characterization of nanopores by Positronium lifetime spectroscopy
-

Basics of Lifetime Spectroscopy

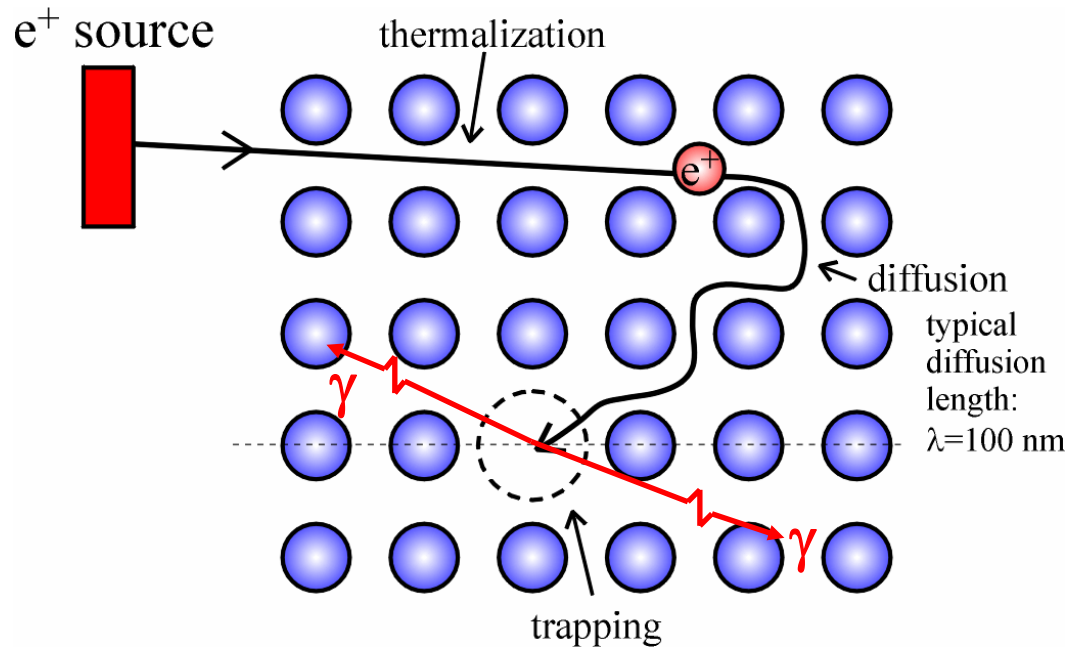
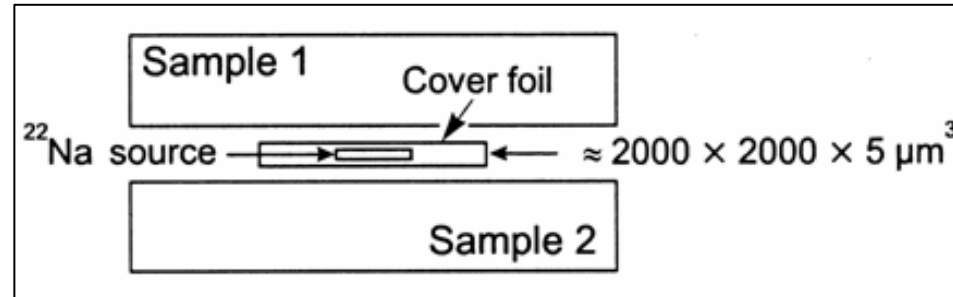
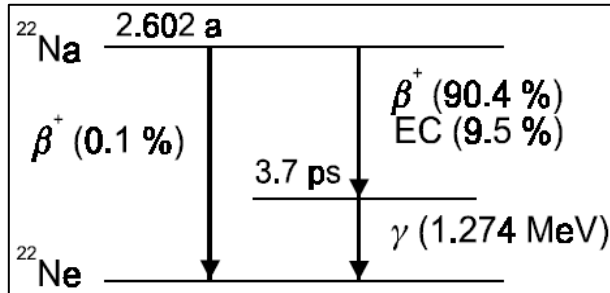

Positrons

- thermalize (reach thermal energies)
- diffuse
- being trapped
- and annihilate

**When positron trapped in vacancies:
 Lifetime increases due to smaller
 electron density in open volume**

Lifetime Measurement

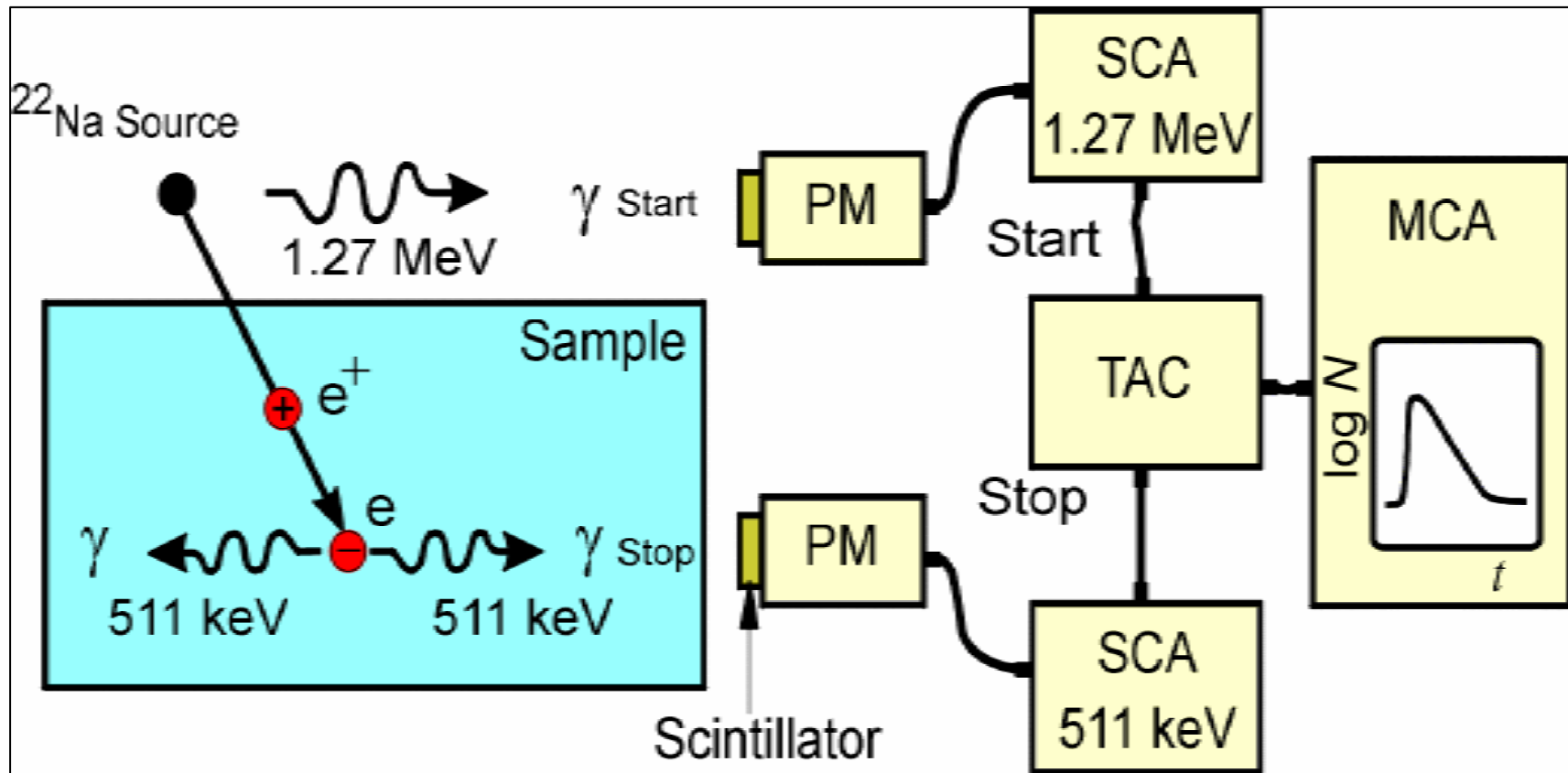

Positron lifetime: time between 1,27 MeV and 0,511 MeV quanta

Lifetime Spectrum

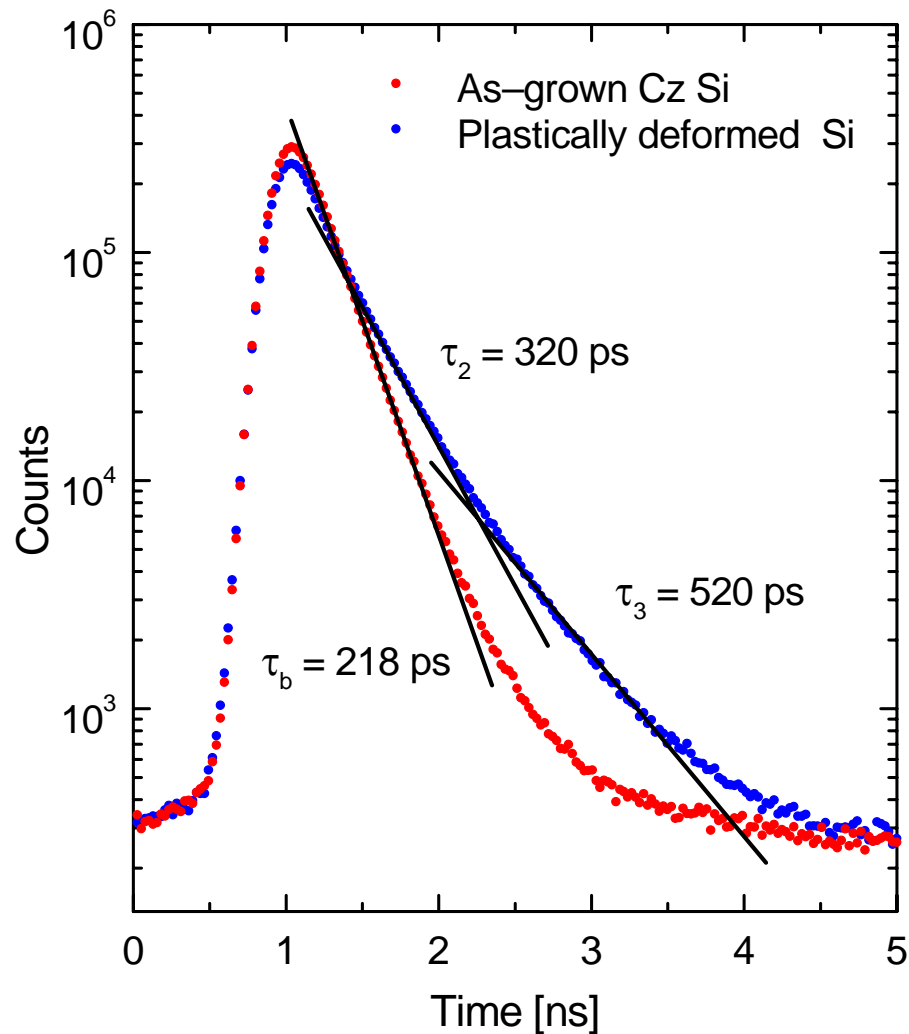

- lifetime spectra consist of exponential decay components
- positron trapping in open-volume defects leads to long-lived lifetime components
- spectra analysis is performed by non-linear fitting routines after source and background subtraction
- experimental result: lifetimes τ_i and intensities I_i

$$N(t) = \sum_{i=1}^{k+1} \frac{I_i}{\tau_i} \exp\left(-\frac{t}{\tau_i}\right)$$

Defects in electron irradiated Ge

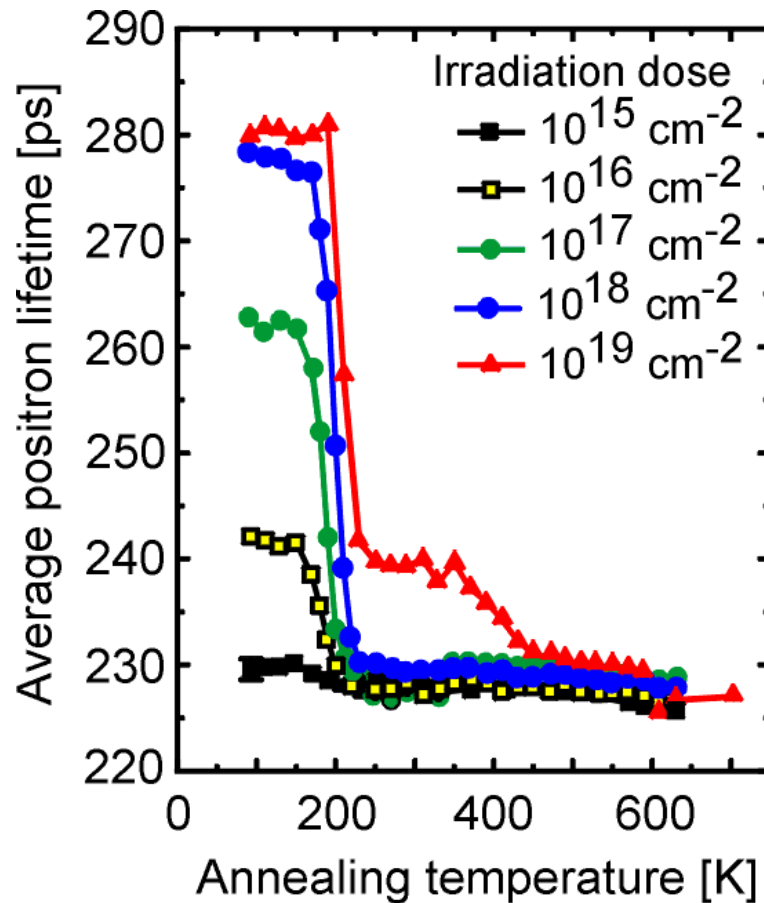

- electron irradiation (2 MeV) at 4K generates Frenkel pairs
- vacancy annealing and defect reactions may be studied

(Polity et al., 1997)

Typical lifetimes

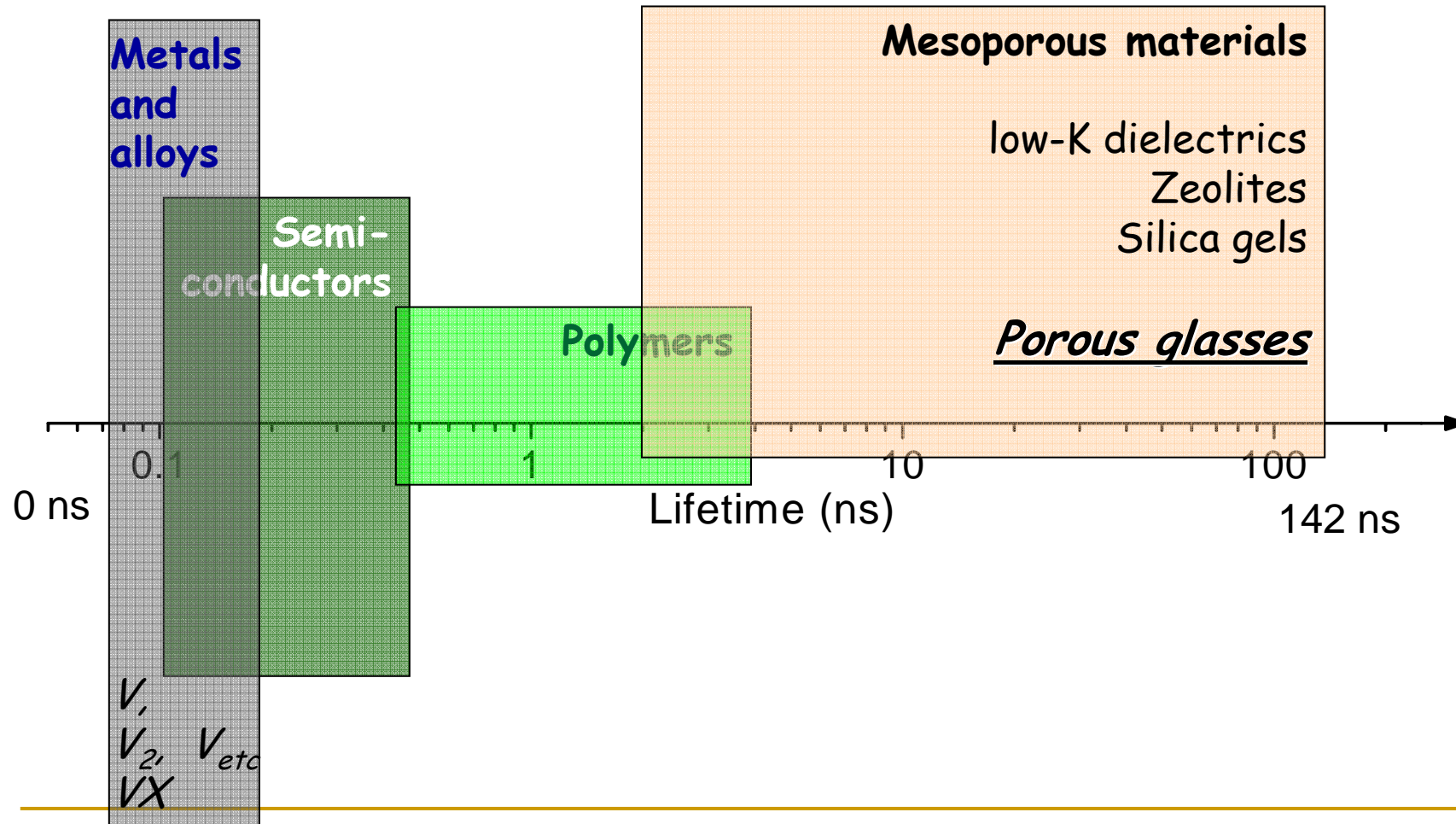

Thermalization

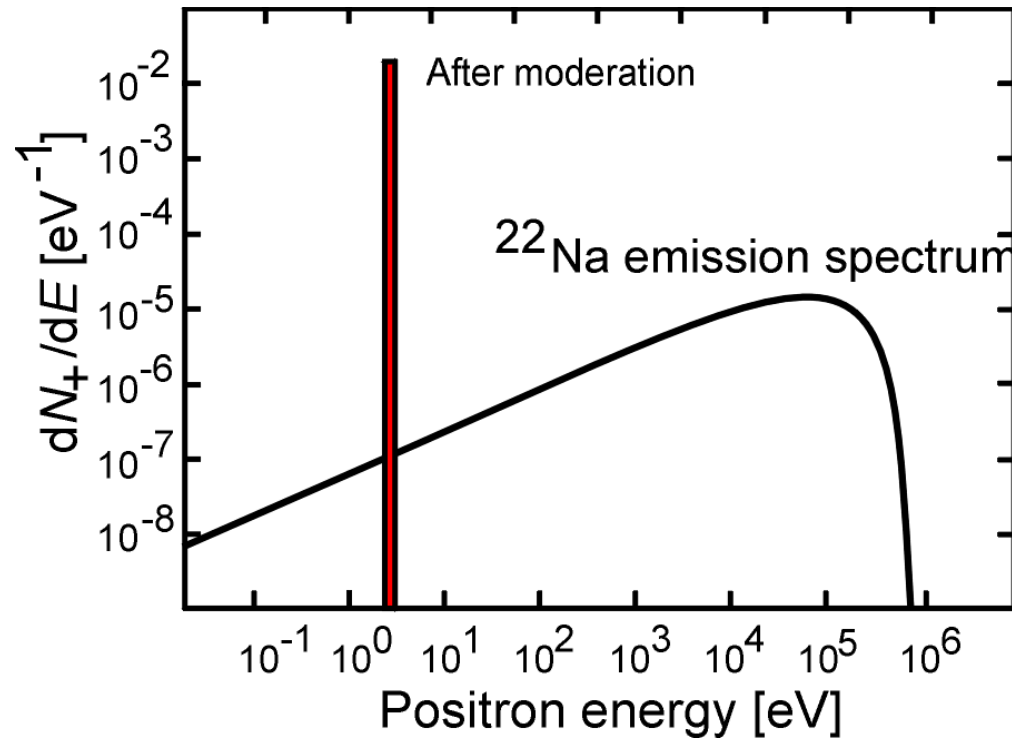

- broad positron emission spectrum
- deep implantation into solids
- not useful for thin layers
- moderation necessary

Mean implantation depth of unmoderated positrons ($1/e$) in Si: $50\mu\text{m}$

Slow positron beam at Halle

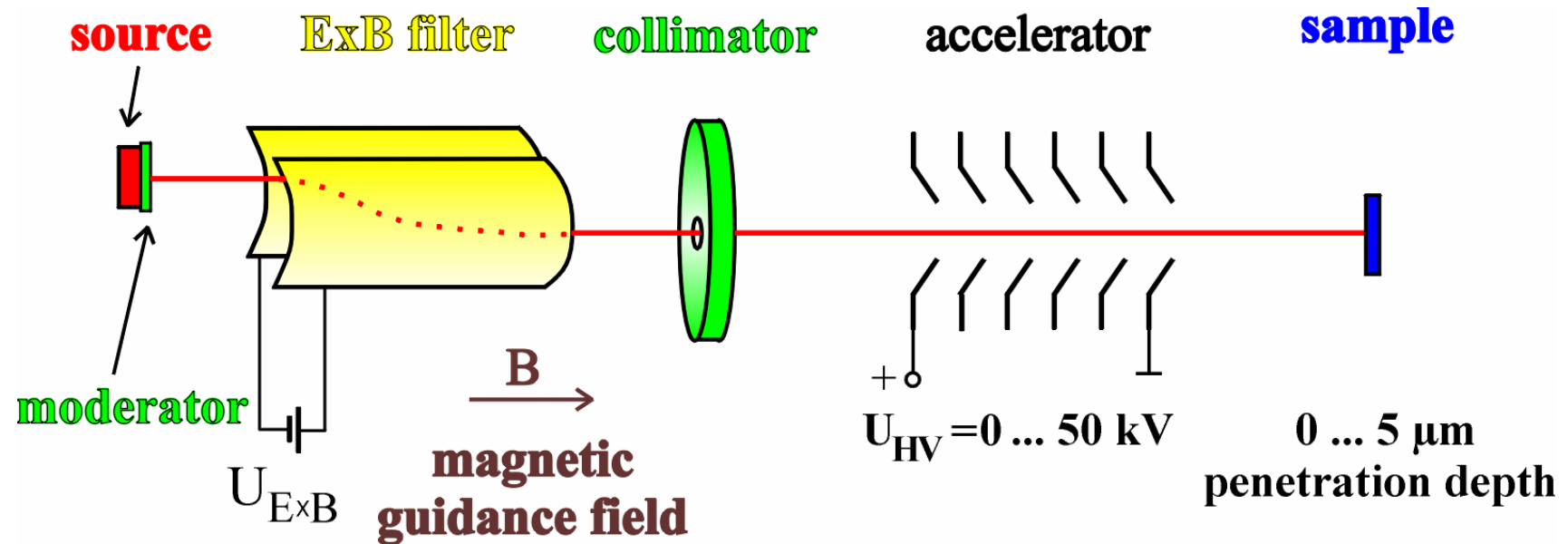

- spot diameter: 5 mm
- time per single spectrum: 20 min
- time per defect-depth scan: 12 hours

Positrons & Positronium

In materials without free electrons Positronium may be formed (Polymers, glass, liquids, gases).

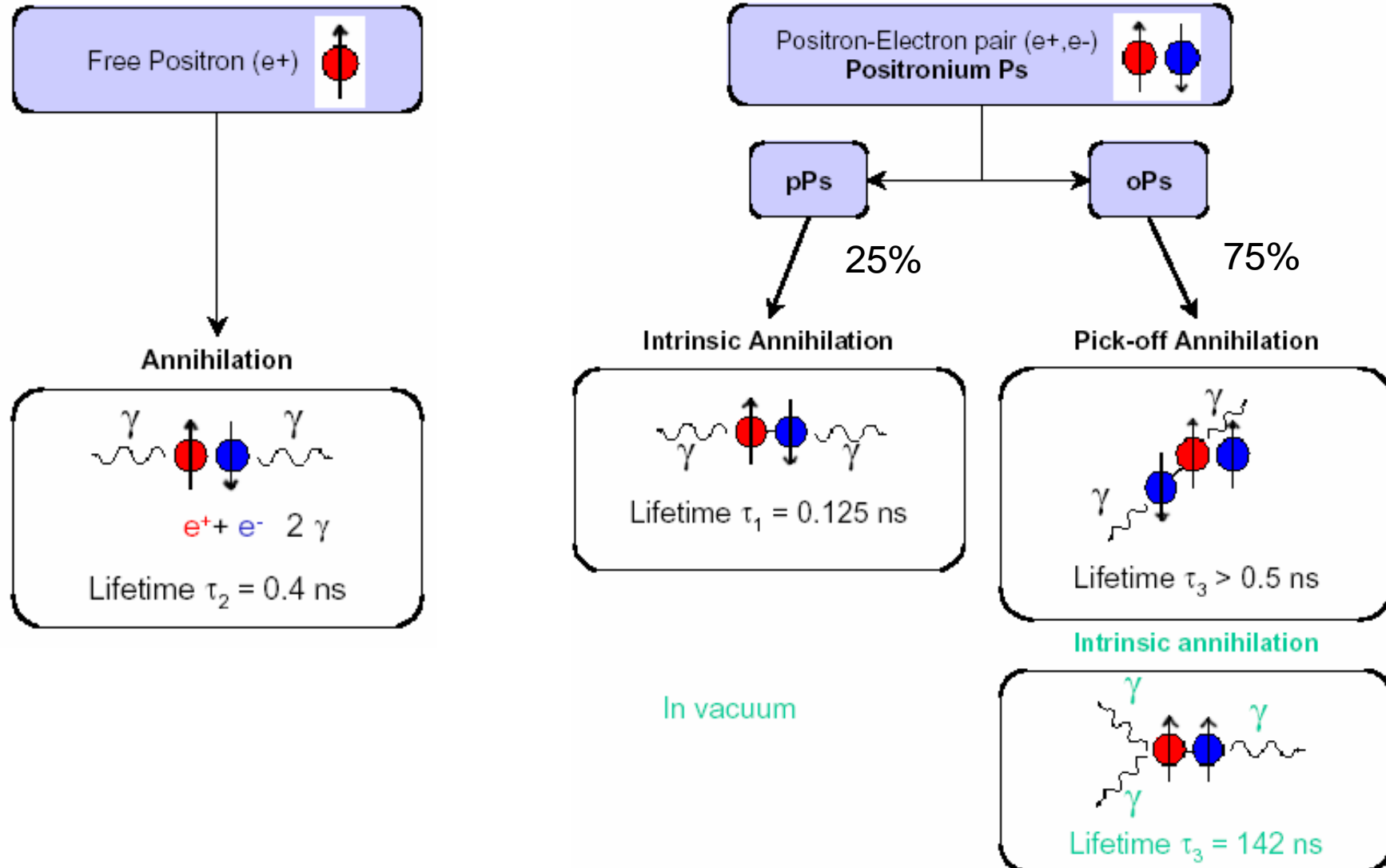

Pick-off Annihilation of o-Ps

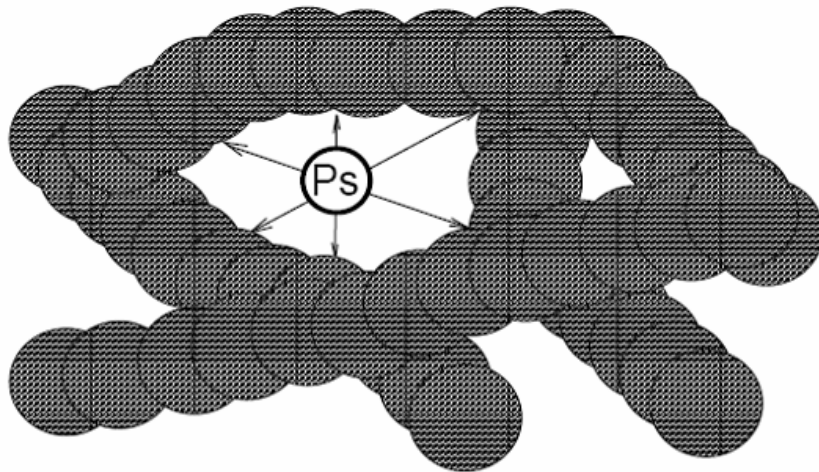

pick-off annihilation

- o-Ps is converted to p-Ps by capturing an electron with anti-parallel spin
 - happens during collisions at walls of pore
 - lifetime decreases rapidly
 - lifetime is function of pore size 1 ns ... 142 ns
-

The TE model

- Annihilation rate:** $\frac{1}{\tau_{o-Ps}} = \lambda_{o-Ps}$
 $= \lambda_{2\gamma} + \lambda_{3\gamma}$
 $= \lambda_{2\gamma}^0 (P) + \lambda_{3\gamma}^0 (1-P) \cong \lambda_{2\gamma}^0 (P)$
 $\lambda_{2\gamma}^0 = \frac{\lambda_S + 3\lambda_T}{4} = \lambda_A \approx 2ns^{-1}$

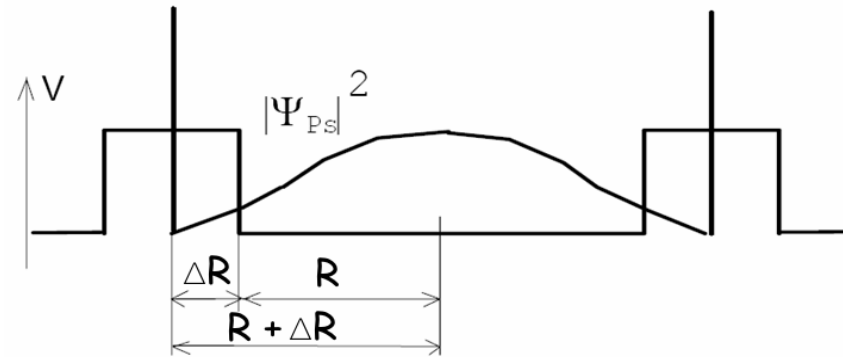

- Pore size < 1 nm -> $\lambda_{3\gamma}$ neglected, only pick off annihilation**

$$\lambda_{TE}(R) = \lambda_A \left[1 - \frac{R}{R + \Delta R} + \frac{1}{2\pi} \sin\left(\frac{2\pi R}{R + \Delta R}\right) \right]$$

- $\Delta R = 0.166$ nm determined by Eldrup**
- Pore size > 1 nm -> $\lambda_{3\gamma}$ can not be neglected, temperature dependence of o-Ps lifetime (excited states)**

The 2 models for $R > 1$ nm - Tokyo

■ Tokyo model:
$$\lambda_{Tokyo}(R) = \begin{cases} \lambda_{TE} + \lambda_{3\gamma} & (R < R_a) \\ \lambda_{TE}(R_a) \left[1 - \left(\frac{R - R_a}{R + \Delta R} \right)^b \right] + \lambda_{3\gamma} & (R \geq R_a) \end{cases}$$

- **Problems:** - no explicit temperature dependence
- two free parameters to be determined

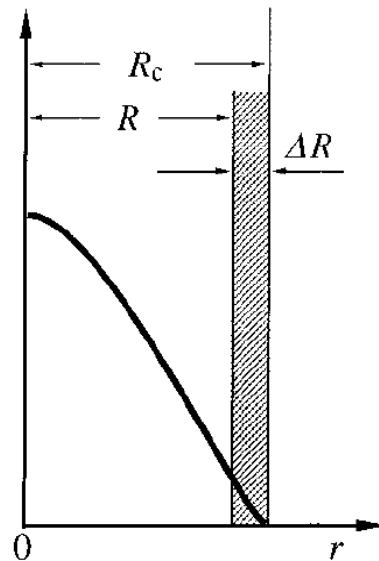

(a) TE

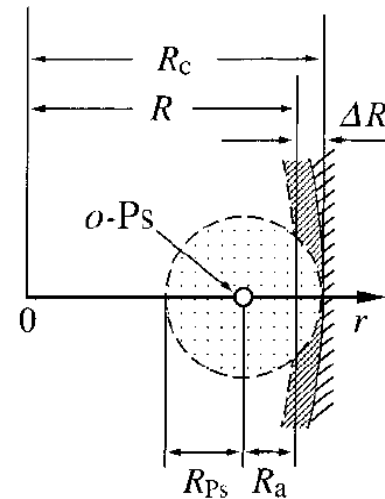

(b) Tokyo

empirical:
 $R_a = 0.8$ nm
 $b = 0.55$

The 2 models for $R > 1$ nm - RTE

- RTE model (for 3D cubic pores):

$$\lambda_{RTE}(D, T) = \lambda_A - \frac{\lambda_S - \lambda_{3\gamma}}{4} \left[1 - \frac{2\delta}{D} + \frac{\sum_{i=1}^{\infty} \frac{1}{i\pi} \sin\left(\frac{2i\pi\delta}{D}\right) e^{\left(\frac{-\beta i^2}{D^2 kT}\right)}}{\sum_{i=1}^{\infty} e^{\left(\frac{-\beta i^2}{D^2 kT}\right)}} \right]^3$$

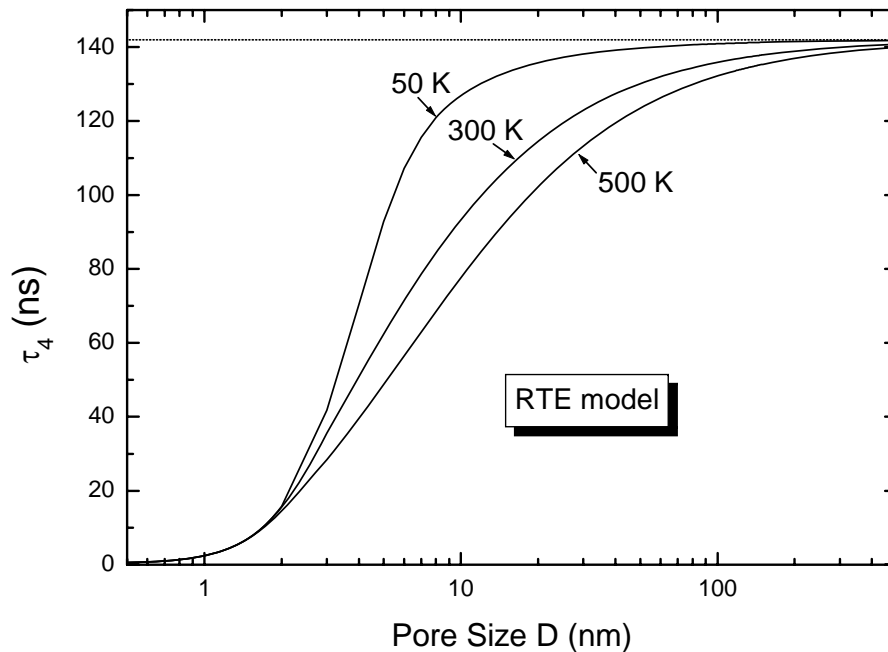

- Boltzmann statistics ascribes explicit temperature dependence to the lifetime
- Rectangular geometry -> prevention of complicated Bessel functions
- $\delta = 0.18$ nm analogous to TE model

Verifying the RTE model

- Porous Vycor Glass

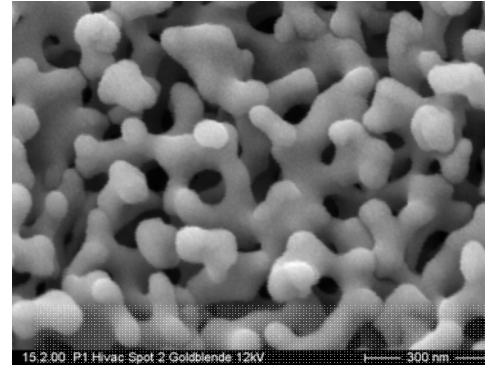

- RTE-Model: the state of the art

- Experimental results

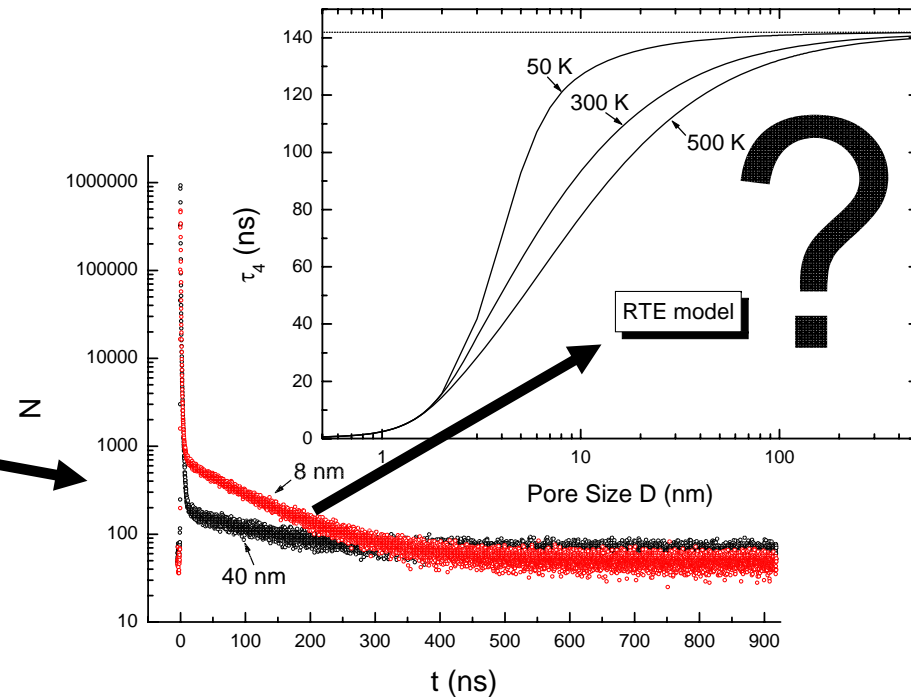

The experiments at $T = 300\text{ K}$

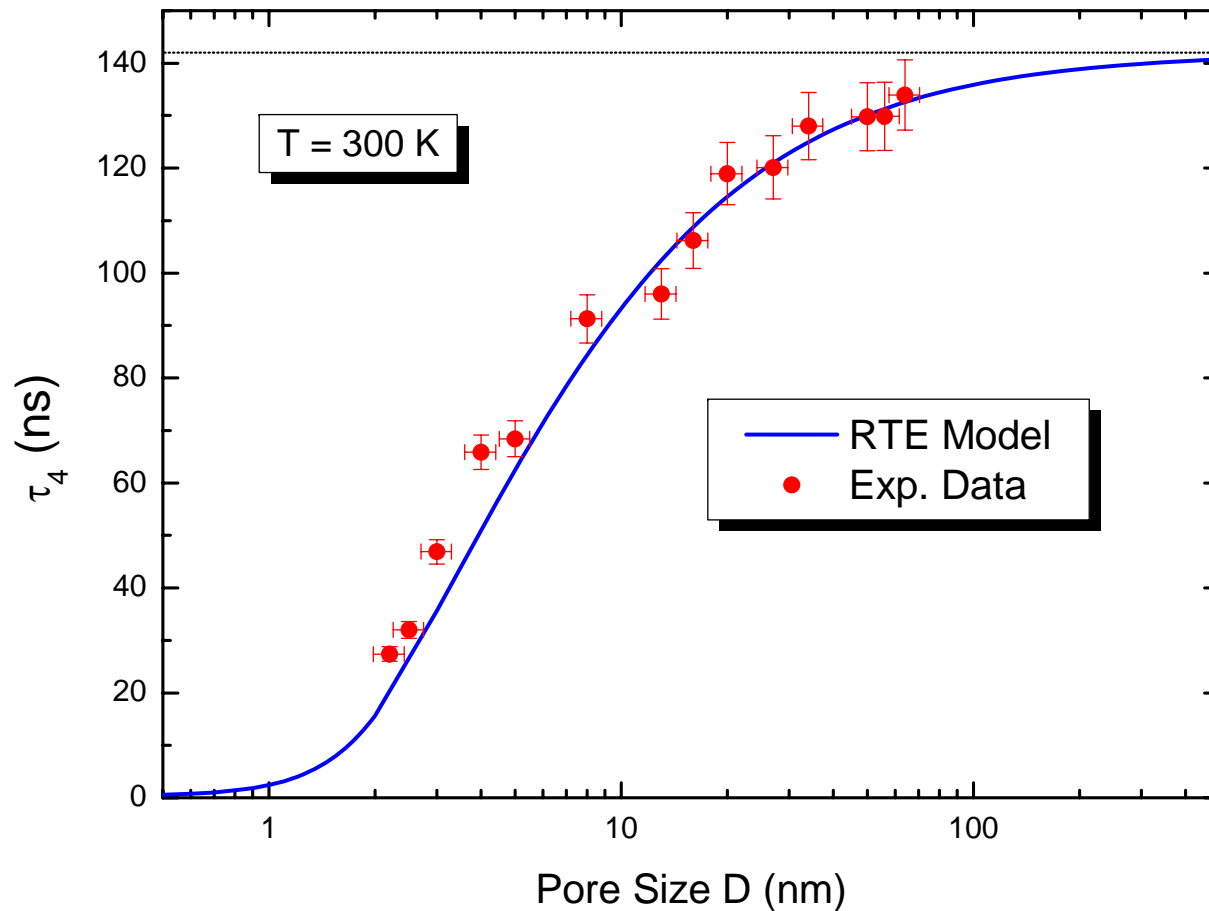

- we measured porous glass in a broad pore size range
- pore size obtained by N_2 -adsorption method
- for $T=300\text{ K}$ general agreement to the RTE model
- calibration curve for the correlation of o-Ps lifetime and pore size

Temperature Dependence

- although we found good agreement for $T = 300$ K
- temperature behavior cannot be explained very well at low temperatures
- model too simple

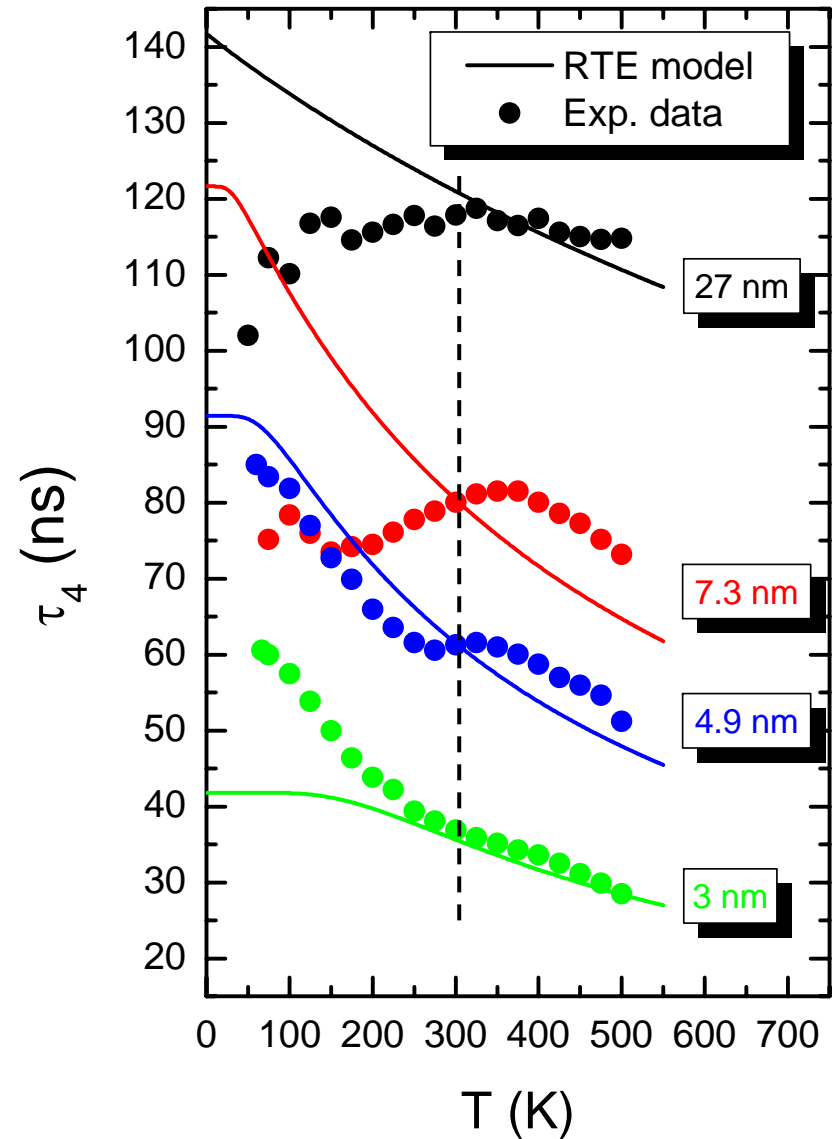

Observation of cryo-condensation in nano-pores

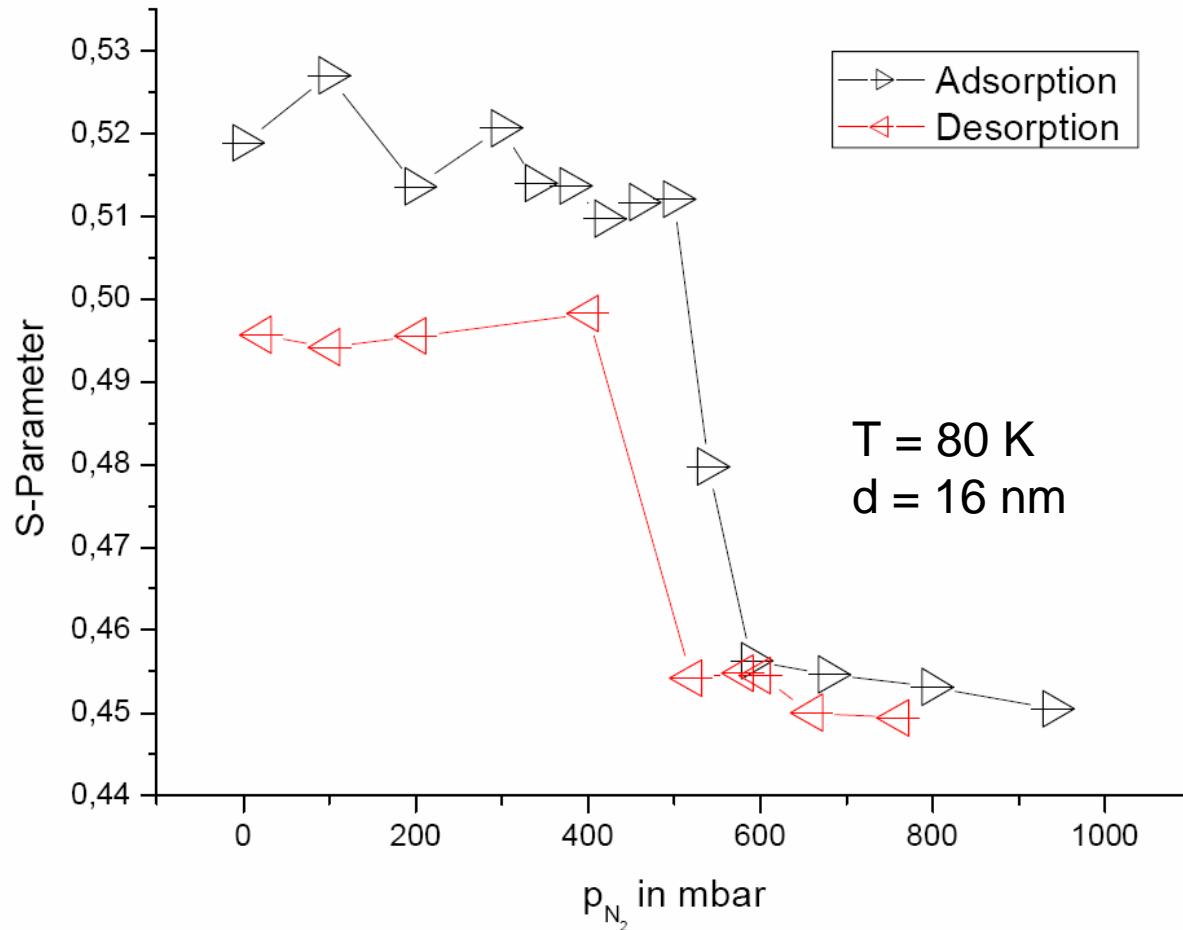

- S-parameter behaves similar like intensity of o- P_s lifetime component
- cryo-condensation can be observed as filling of pores
- phase transition can be studied in a nano-volume as function of size, gas, T and p

Summary

- Time spectroscopy of o-Ps is a very sensitive tool for characterization of nano-pores
 - most sensitive in range 0.5 ... 30 nm
 - closed and open pores
 - positron beam can be used: fully non-destructive (no contact to sample)
-